

ARM® Cortex®-M7 Processor

Revision r1p1

Technical Reference Manual



ARM Cortex-M7 Processor

Technical Reference Manual

Copyright © 2014, 2015 ARM. All rights reserved.

Release Information

The following changes have been made to this book.

Change history			
Date	Issue	Confidentiality	Change
25 April 2014	A	Confidential	First release for r0p0
05 December 2014	B	Non-Confidential	First release for r0p2
19 March 2015	C	Non-Confidential	First release for r1p0
07 July 2015	D	Non-Confidential	First release for r1p1

Proprietary Notice

This document is protected by copyright and other related rights and the practice or implementation of the information contained in this document may be protected by one or more patents or pending patent applications. No part of this document may be reproduced in any form by any means without the express prior written permission of ARM. No license, express or implied, by estoppel or otherwise to any intellectual property rights is granted by this document unless specifically stated.

Your access to the information in this document is conditional upon your acceptance that you will not use or permit others to use the information for the purposes of determining whether implementations infringe any third party patents.

THIS DOCUMENT IS PROVIDED “AS IS”. ARM PROVIDES NO REPRESENTATIONS AND NO WARRANTIES, EXPRESS, IMPLIED OR STATUTORY, INCLUDING, WITHOUT LIMITATION, THE IMPLIED WARRANTIES OF MERCHANTABILITY, SATISFACTORY QUALITY, NON-INFRINGEMENT OR FITNESS FOR A PARTICULAR PURPOSE WITH RESPECT TO THE DOCUMENT. For the avoidance of doubt, ARM makes no representation with respect to, and has undertaken no analysis to identify or understand the scope and content of, third party patents, copyrights, trade secrets, or other rights.

This document may include technical inaccuracies or typographical errors.

TO THE EXTENT NOT PROHIBITED BY LAW, IN NO EVENT WILL ARM BE LIABLE FOR ANY DAMAGES, INCLUDING WITHOUT LIMITATION ANY DIRECT, INDIRECT, SPECIAL, INCIDENTAL, PUNITIVE, OR CONSEQUENTIAL DAMAGES, HOWEVER CAUSED AND REGARDLESS OF THE THEORY OF LIABILITY, ARISING OUT OF ANY USE OF THIS DOCUMENT, EVEN IF ARM HAS BEEN ADVISED OF THE POSSIBILITY OF SUCH DAMAGES.

This document consists solely of commercial items. You shall be responsible for ensuring that any use, duplication or disclosure of this document complies fully with any relevant export laws and regulations to assure that this document or any portion thereof is not exported, directly or indirectly, in violation of such export laws. Use of the word “partner” in reference to ARM’s customers is not intended to create or refer to any partnership relationship with any other company. ARM may make changes to this document at any time and without notice.

If any of the provisions contained in these terms conflict with any of the provisions of any signed written agreement covering this document with ARM, then the signed written agreement prevails over and supersedes the conflicting provisions of these terms. This document may be translated into other languages for convenience, and you agree that if there is any conflict between the English version of this document and any translation, the terms of the English version of the Agreement shall prevail.

Words and logos marked with ® or ™ are registered trademarks or trademarks of ARM Limited or its affiliates in the EU and/or elsewhere. All rights reserved. Other brands and names mentioned in this document may be the trademarks of their respective owners. Please follow ARM’s trademark usage guidelines at <http://www.arm.com/about/trademark-usage-guidelines.php>

Copyright © 2015, ARM Limited or its affiliates. All rights reserved.

ARM Limited. Company 02557590 registered in England.

110 Fulbourn Road, Cambridge, England CB1 9NJ.

Confidentiality Status

This document is Non-Confidential. The right to use, copy and disclose this document may be subject to license restrictions in accordance with the terms of the agreement entered into by ARM and the party that ARM delivered this document to.

Product Status

The information in this document is final, that is for a developed product.

Web Address

<http://www.arm.com>

Contents

ARM Cortex-M7 Processor Technical Reference Manual

	Preface	
	About this book	vii
	Feedback	xi
Chapter 1	Introduction	
	1.1 About the Cortex-M7 processor	1-2
	1.2 Component blocks	1-6
	1.3 Interfaces	1-11
	1.4 Supported standards	1-13
	1.5 Design process	1-14
	1.6 Documentation	1-15
	1.7 Product revisions	1-16
Chapter 2	Programmers Model	
	2.1 About the programmers model	2-2
	2.2 Modes of operation and execution	2-3
	2.3 Instruction set summary	2-4
	2.4 System address map	2-5
	2.5 Exclusive monitor	2-7
	2.6 Processor core registers	2-8
	2.7 Exceptions	2-9
Chapter 3	System Control	
	3.1 About system control	3-2
	3.2 Register summary	3-3
	3.3 Register descriptions	3-6

Chapter 4	Initialization	
	4.1 About Initialization	4-2
Chapter 5	Memory System	
	5.1 About the memory system	5-2
	5.2 Fault handling	5-3
	5.3 Memory types and memory system behavior	5-5
	5.4 AXIM interface	5-6
	5.5 AHB peripheral interface	5-22
	5.6 AHB slave interface	5-30
	5.7 TCM interfaces	5-33
	5.8 L1 caches	5-37
Chapter 6	Memory Protection Unit	
	6.1 About the MPU	6-2
	6.2 MPU functional description	6-3
	6.3 MPU programmers model	6-4
Chapter 7	Nested Vectored Interrupt Controller	
	7.1 About the NVIC	7-2
	7.2 NVIC functional description	7-3
	7.3 NVIC programmers model	7-4
Chapter 8	Floating Point Unit	
	8.1 About the FPU	8-2
	8.2 FPU functional description	8-3
	8.3 FPU programmers model	8-5
Chapter 9	Debug	
	9.1 About debug	9-2
	9.2 About the AHBD interface	9-7
	9.3 About the FPB	9-8
Chapter 10	Cross Trigger Interface	
	10.1 About the CTI	10-2
	10.2 Cortex-M7 CTI functional description	10-3
	10.3 CTI programmers model	10-5
Chapter 11	Data Watchpoint and Trace Unit	
	11.1 About the DWT	11-2
	11.2 DWT functional description	11-3
	11.3 DWT programmers model	11-4
Chapter 12	Instrumentation Trace Macrocell Unit	
	12.1 About the ITM	12-2
	12.2 ITM functional description	12-3
	12.3 ITM programmers model	12-4
Chapter 13	Fault detection and handling	
	13.1 About fault detection and handling	13-2
	13.2 Cache RAM protection	13-3
	13.3 Logic protection	13-6
Appendix A	Revisions	

Preface

This preface introduces the *Cortex-M7 Processor Technical Reference Manual* (TRM). It contains the following sections:

- *About this book* on page vii.
- *Feedback* on page xi.

About this book

This book is for the Cortex-M7 processor.

Product revision status

The *mpn* identifier indicates the revision status of the product described in this manual, where:

- rn** Identifies the major revision of the product.
- pn** Identifies the minor revision or modification status of the product.

Intended audience

This manual is written to help system designers, system integrators, verification engineers, and software programmers who are implementing a *System-on-Chip* (SoC) device based on the Cortex-M7 processor.

Using this book

This book is organized into the following chapters:

Chapter 1 *Introduction*

Read this for a description of the components of the processor, and of the product documentation.

Chapter 2 *Programmers Model*

Read this for a description of the processor register set, modes of operation, and other information for programming the processor.

Chapter 3 *System Control*

Read this for a description of the registers and programmers model for system control.

Chapter 4 *Initialization*

Read this for a description of how to initialize the processor.

Chapter 5 *Memory System*

Read this for a description of the processor memory system.

Chapter 6 *Memory Protection Unit*

Read this for a description of the *Memory Protection Unit* (MPU).

Chapter 7 *Nested Vectored Interrupt Controller*

Read this for a description of the interrupt processing and control.

Chapter 8 *Floating Point Unit*

Read this for a description of the *Floating Point Unit* (FPU).

Chapter 9 *Debug*

Read this for information about debugging and testing the processor.

Chapter 10 *Cross Trigger Interface*

Read this for information about how the *Cross Trigger Interface* (CTI) can be configured.

Chapter 11 *Data Watchpoint and Trace Unit*

Read this for a description of the *Data Watchpoint and Trace* (DWT) unit.

Chapter 12 *Instrumentation Trace Macrocell Unit*

Read this for a description of the *Instrumentation Trace Macrocell* (ITM) unit.

Chapter 13 *Fault detection and handling*

Read this for a description about how faults are detected and handled in the Cortex-M7 Processor.

Appendix A *Revisions*

Read this for a description of the technical changes between released issues of this book.

Glossary

The *ARM® Glossary* is a list of terms used in ARM documentation, together with definitions for those terms. The *ARM® Glossary* does not contain terms that are industry standard unless the ARM meaning differs from the generally accepted meaning.

See *ARM® Glossary*, <http://infocenter.arm.com/help/topic/com.arm.doc.aeg0014-/index.html>.

Conventions

This book uses the conventions that are described in:

- *Typographical conventions*.
- *Timing diagrams on page ix*.
- *Signals on page ix*.

Typographical conventions

The following table describes the typographical conventions:

Style	Purpose
<i>italic</i>	Introduces special terminology, denotes cross-references, and citations.
bold	Highlights interface elements, such as menu names. Denotes signal names. Also used for terms in descriptive lists, where appropriate.
monospace	Denotes text that you can enter at the keyboard, such as commands, file and program names, and source code.
<u>monospace</u>	Denotes a permitted abbreviation for a command or option. You can enter the underlined text instead of the full command or option name.
monospace <i>italic</i>	Denotes arguments to monospace text where the argument is to be replaced by a specific value.
monospace bold	Denotes language keywords when used outside example code.
<and>	Encloses replaceable terms for assembler syntax where they appear in code or code fragments. For example: LDRSB<cond> <Rt>, [<Rn>, #<offset>]
SMALL CAPITALS	Used in body text for a few terms that have specific technical meanings, that are defined in the <i>ARM glossary</i> . For example, IMPLEMENTATION DEFINED, IMPLEMENTATION SPECIFIC, UNKNOWN, and UNPREDICTABLE.

Timing diagrams

The figure named *Key to timing diagram conventions* explains the components used in timing diagrams. Variations, when they occur, have clear labels. You must not assume any timing information that is not explicit in the diagrams.

Shaded bus and signal areas are UNDEFINED, so the bus or signal can assume any value within the shaded area at that time. The actual level is unimportant and does not affect normal operation.

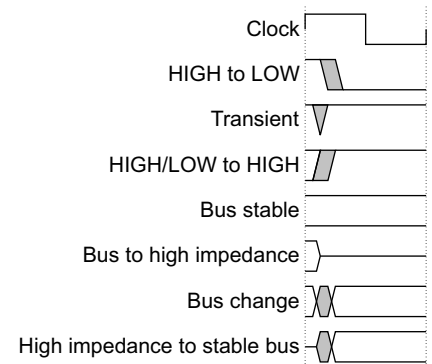

Key to timing diagram conventions

Timing diagrams sometimes show single-bit signals as HIGH and LOW at the same time and they look similar to the bus change shown in *Key to timing diagram conventions*. If a timing diagram shows a single-bit signal in this way then its value does not affect the accompanying description.

Signals

The signal conventions are:

Signal level The level of an asserted signal depends on whether the signal is active-HIGH or active-LOW. Asserted means:

- HIGH for active-HIGH signals.
- LOW for active-LOW signals.

Lower-case n At the start or end of a signal name denotes an active-LOW signal.

Additional reading

This section lists publications by ARM and by third parties.

See *Infocenter*, <http://infocenter.arm.com>, for access to ARM documentation.

See on ARM, www.arm.com/cmsis, for embedded software development resources including the *Cortex Microcontroller Software Interface Standard (CMSIS)*.

ARM publications

This book contains information that is specific to this product. See the following documents for other relevant information:

- *ARM[®]v7-M Architecture Reference Manual* (ARM DDI 0403).
- *ARM[®] CoreLink[™] Level 2 Cache Controller L2C-310 Technical Reference Manual* (ARM DDI 0246).
- *ARM[®] CoreSight[™] ETM-M7 Technical Reference Manual* (ARM DDI 0494).
- *ARM[®] AMBA[®] AXI and ACE Protocol Specification* (ARM IHI 0022).
- *ARM[®] AMBA[®] 3 AHB-Lite Protocol (v1.0)* (ARM IHI 0033).
- *ARM[®] AMBA[®] 3 ATB Protocol Specification* (ARM IHI 0032).
- *ARM[®] AMBA[®] 3 APB Protocol Specification* (ARM IHI 0024).
- *ARM[®] CoreSight[™] SoC-400 Technical Reference Manual* (ARM DDI 0480).
- *ARM[®] CoreSight[™] Architecture Specification (v2.0)* (ARM IHI 0029).
- *ARM[®] Debug Interface v5 Architecture Specification* (ARM IHI 0031).
- *ARM[®] Embedded Trace Macrocell Architecture Specification ETMv4* (ARM IHI 0064).

The following confidential books are only available to licensees:

- *ARM[®] Cortex[®]-M7 Processor Integration and Implementation Manual* (ARM DII 0239).

Other publications

This section lists relevant documents published by third parties:

- *Test Access Port and Boundary-Scan Architecture*, IEEE Standard 1149.1-2001 (JTAG).
- *IEEE Standard for Binary Floating-Point Arithmetic*, IEEE Standard 754-2008.

Feedback

ARM welcomes feedback on this product and its documentation.

Feedback on this product

If you have any comments or suggestions about this product, contact your supplier and give:

- The product name.
- The product revision or version.
- An explanation with as much information as you can provide. Include symptoms and diagnostic procedures if appropriate.

Feedback on content

If you have comments on content then send an e-mail to errata@arm.com. Give:

- The title.
- The number, ARM DDI 0489D.
- The page numbers to which your comments apply.
- A concise explanation of your comments.

ARM also welcomes general suggestions for additions and improvements.

———— **Note** —————

ARM tests the PDF only in Adobe Acrobat and Acrobat Reader, and cannot guarantee the quality of the represented document when used with any other PDF reader.

Chapter 1

Introduction

This chapter introduces the processor. It contains the following sections:

- *About the Cortex-M7 processor* on page 1-2.
- *Component blocks* on page 1-6.
- *Interfaces* on page 1-11.
- *Supported standards* on page 1-13.
- *Design process* on page 1-14.
- *Documentation* on page 1-15.
- *Product revisions* on page 1-16.

1.1 About the Cortex-M7 processor

The Cortex-M7 processor is a highly efficient high-performance, embedded processor that features low interrupt latency, low-cost debug, and has backwards compatibility with existing Cortex-M profile processors. The processor has an in-order super-scalar pipeline that means many instructions can be dual-issued, including load/load and load/store instruction pairs because of multiple memory interfaces.

Memory interfaces that the processor supports include:

- *Tightly-Coupled Memory (TCM)* interfaces.
- Harvard instruction and data caches and *AXI master (AXIM)* interface.
- Dedicated low-latency *AHB-Lite peripheral (AHBP)* interface.
- *AHB-Lite slave (AHBS)* interface that provides DMA access to TCMs.

The processor has an optional *Memory Protection Unit (MPU)* that you can configure to protect regions of memory. *Error Correcting Code (ECC)* functionality for error detection and correction, is included in the data and instruction caches when implemented. The TCM interfaces support the implementation of external ECC to provide improved reliability and to address safety-related applications.

The Cortex-M7 processor includes optional floating-point arithmetic functionality, with support for single and double-precision arithmetic. See [Chapter 8 Floating Point Unit](#).

The processor is intended for high-performance, deeply embedded applications that require fast interrupt response features.

[Figure 1-1](#) shows the processor in a typical system.

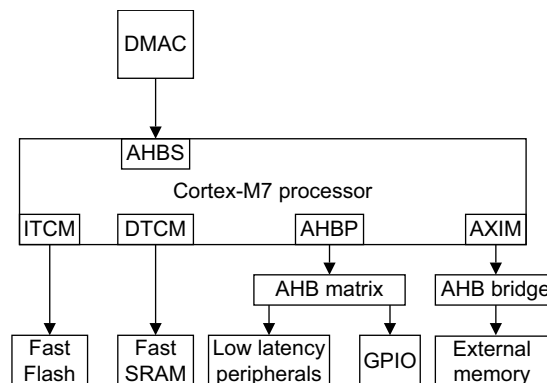

Figure 1-1 Example Cortex-M7 system

1.1.1 Features

The main features of the Cortex-M7 processor include:

- An in-order issue, super-scalar pipeline with dynamic branch prediction.
- DSP extensions.
- The ARMv7-M Thumb® instruction set, defined in the *ARM®v7-M Architecture Reference Manual*.
- Banked *Stack Pointer (SP)*.
- Hardware integer divide instructions, SDIV and UDIV.
- Handler and Thread modes.

- Thumb and Debug states.
- Automatic processor state saving and restoration for low-latency *Interrupt Service Routine* (ISR) entry and exit.
- Support for ARMv7-M big-endian byte-invariant or little-endian accesses.
- Support for ARMv7-M unaligned accesses.
- Low-latency interrupt processing achieved by:
 - A *Nested Vectored Interrupt Controller* (NVIC) closely integrated with the processor.
 - Supporting exception-continuable instructions, such as LDM, LDMDB, STM, STMDB, PUSH, POP and VLDM, VSTM, VPOP, VPOP if the processor has the *Floating Point Unit* (FPU).
- A low-cost debug solution with the optional ability to:
 - Implement breakpoints.
 - Implement watchpoints, tracing, and system profiling.
 - Support printf() style debugging through an *Instrumentation Trace Macrocell* (ITM).
 - Optional *Trace Port Interface Unit* (TPIU).
 - Optional *Debug Access Port* (DAP).
- Support for an optional *Embedded Trace Macrocell* (ETM). See the *ARM® CoreSight™ ETM-M7 Technical Reference Manual* for more information.
- A memory system, that includes an optional MPU and Harvard data and instruction cache with ECC.
- An optional *Floating Point Unit* (FPU).
- Low-power features including architectural clock gating, sleep mode and *Wake-up Interrupt Controller* (WIC).
- Optional AXI to AHB bridge for legacy memory system support.

1.1.2 Interfaces

The Cortex-M7 processor has a number of external interfaces.

[Figure 1-2 on page 1-4](#) shows the external interfaces of the Cortex-M7 processor.

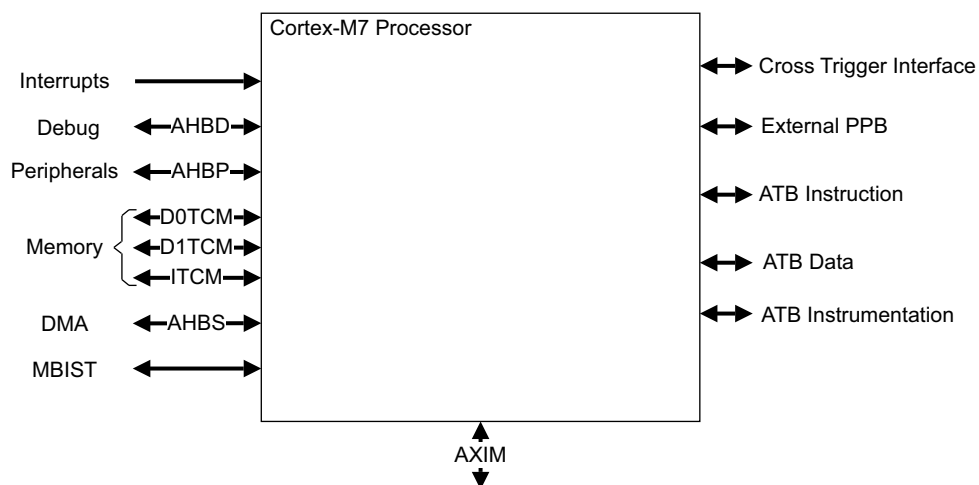

Figure 1-2 Cortex-M7 processor interfaces

1.1.3 Configuration options

The Cortex-M7 processor has configurable options that you can configure during the implementation and integration stages to match your functional requirements.

Table 1-1 shows the configurable options at build time of the processor.

Table 1-1 Implementation options

Feature	Options	Done at
Floating-point	No floating-point.	Implementation
	Single-precision floating-point only.	
	Single-precision and double-precision floating-point.	
Instruction TCM	No instruction TCM.	Integration
	4KB-16MB (powers of 2).	
Data TCM	No data TCM.	Integration
	4KB-16MB (powers of 2). The Data TCM is split equally into two TCMs, D0TCM, and D1TCM.	
Instruction cache	No <i>instruction cache unit (ICU)</i> ^a .	Implementation
	Instruction cache unit is included.	
Data cache	Area optimized AXIM interface, no <i>data cache unit (DCU)</i> ^b .	Implementation
	Performance optimized AXIM interface, data cache unit is included.	
Instruction cache size	4KB, 8KB, 16KB, 32KB, 64KB.	Integration
Data cache size	4KB, 8KB, 16KB, 32KB, 64KB.	Integration
AHB peripheral size	64MB, 128MB, 256MB, 512MB.	Integration
ECC support on caches	No ECC on instruction cache or data cache.	Implementation
	ECC on all implemented caches.	

Table 1-1 Implementation options (continued)

Feature	Options	Done at
Protected memory regions	0 region, 8 regions, 16 regions.	Implementation
Interrupts	1-240 interrupts.	Implementation
Number bits of interrupt priority	Between three and eight bits of interrupt priority, between 8 and 256 levels of priority.	Implementation
Debug watchpoints and breakpoints	Reduced set. Two data watchpoints comparators and four breakpoint comparators. Full set. Four data watchpoints comparators and eight breakpoint comparators.	Implementation
ITM and <i>Data Watchpoint and Trace (DWT)</i> trace functionality	No ITM or DWT trace. Complete ITM and DWT trace.	Implementation
ETM	No ETM support. ETM instruction trace only. ETM instruction and data trace.	Implementation
Dual-redundant processor	No dual-redundant processor. Dual-redundant processor included.	Implementation
Reset All Registers	Only required registers that must be initialized are reset in the RTL. All registers are reset in the RTL excluding those in the ETM, if included. All registers are reset in the RTL including those in the ETM, if included.	Implementation
<i>Cross Trigger Interface (CTI)</i>	No Cross Trigger Interface. Cross Trigger Interface included.	Implementation
<i>Wake-up Interrupt Controller (WIC)</i>	No Wake-up Interrupt controller. Wake-up Interrupt controller included.	Implementation

- a. The ICU includes an instruction cache controller.
- b. The DCU includes a data cache controller.

1.2 Component blocks

The Cortex-M7 processor has fixed and optional component blocks. Optional components are:

- *Wake-up Interrupt Controller (WIC).*
- ITM.
- FPU.
- MPU.
- Instruction cache unit.
- Data cache unit.
- *Cross Trigger Interface (CTI).*
- ETM.

All other components are fixed.

Table 1-1 on page 1-4 shows the configurable options at implementation time of the processor.

Figure 1-3 shows the optional and fixed components of the Cortex-M7 processor.

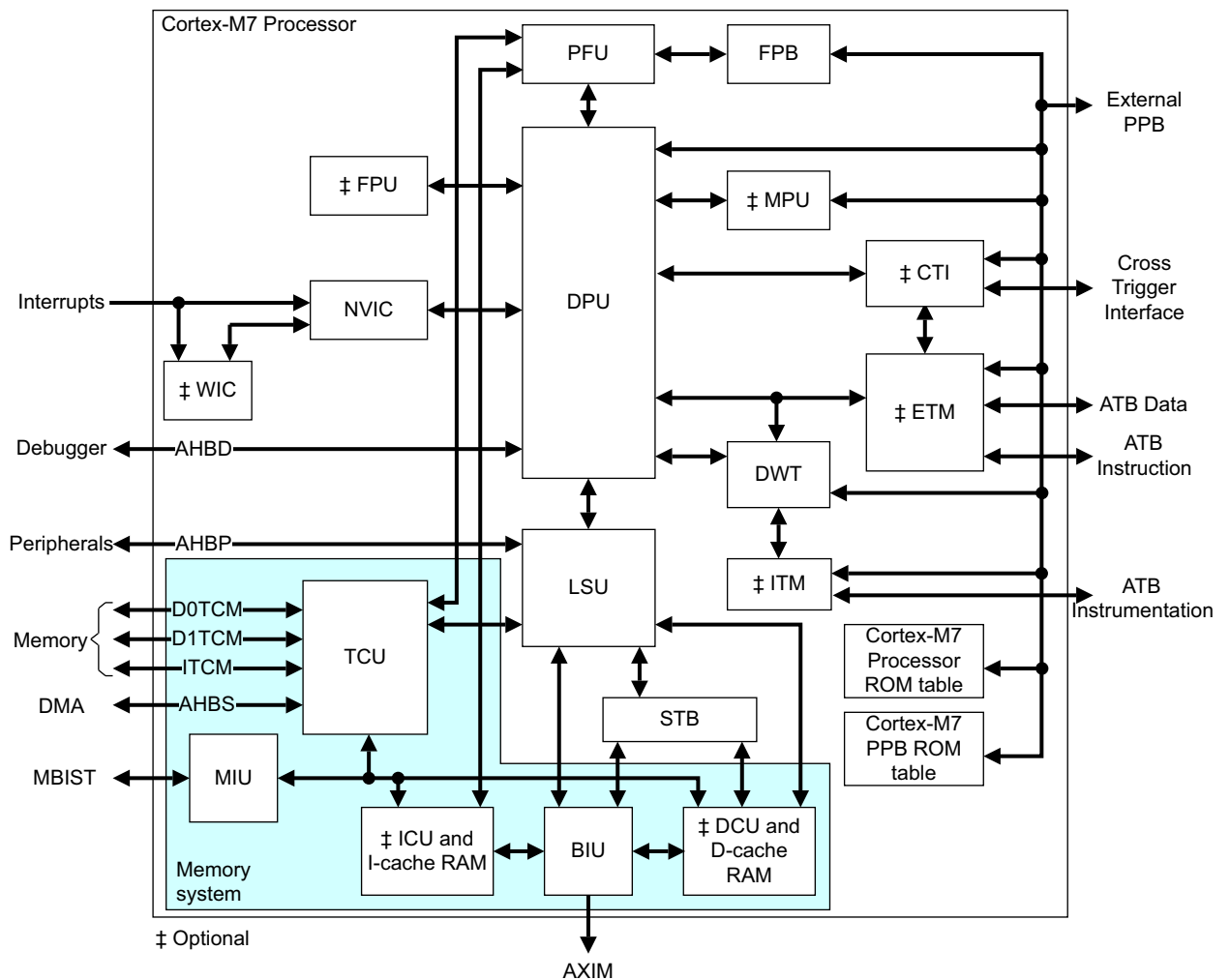

Figure 1-3 Cortex-M7 functional diagram

The Cortex-M7 processor contains the following component blocks:

- *Data Processing Unit.*
- *Prefetch Unit.*
- *Load Store Unit.*
- *Floating Point Unit* on page 1-8.
- *Nested Vectored Interrupt Controller* on page 1-8.
- *Wake-up Interrupt Controller* on page 1-8.
- *Memory System* on page 1-9.
- *Memory Protection Unit* on page 1-9.
- *Cortex-M7 Processor and PPB ROM tables* on page 1-9.
- *Cross Trigger Interface Unit* on page 1-9.
- *ETM* on page 1-9.
- *Debug and trace components* on page 1-9.

1.2.1 Data Processing Unit

The *Data Processing Unit* (DPU) provides:

- Parallelized integer register file with six read ports and four write ports for large-scale dual-issue.
- Extensive forwarding logic to minimise interlocks.
- Two ALUs, with one ALU capable of executing SIMD operations.
- Single MAC pipeline capable of 32x32-bit + 64-bit → 64-bit with two cycle result latency and one MAC per cycle throughput.
- Single divider unit with support for operand-dependent early termination.

1.2.2 Prefetch Unit

The *Prefetch Unit* (PFU) provides:

- 64-bit instruction fetch bandwidth.
- 4x64-bit pre-fetch queue to decouple instruction pre-fetch from DPU pipeline operation.
- A *Branch Target Address Cache* (BTAC) for single-cycle turn-around of branch predictor state and target address.
- A static branch predictor when no BTAC is specified.
- Forwarding of flags for early resolution of direct branches in the decoder and first execution stages of the processor pipeline.

1.2.3 Load Store Unit

The *Load Store Unit* (LSU) provides:

- Dual 32-bit load channels to TCM, data cache, and *AXI master* (AXIM) interface for 64-bit load bandwidth and dual 32-bit load capability.
- Single 32-bit load channel to the AHB interface.
- Single 64-bit store channel.

- Store buffering to increase store throughput and minimize RAM contention with data and instruction reads.
- Separate store buffering for TCM, AHBP and AXIM for *Quality of Service* (QoS) and interface-specific optimizations.

1.2.4 Floating Point Unit

The optional *Floating Point Unit* (FPU) provides:

- Lazy floating-point context save. Automated stacking of floating-point state is delayed until the ISR attempts to execute a floating-point instruction. This reduces the latency to enter the ISR and removes floating-point context save for ISRs that do not use floating-point.
- Instructions for single-precision (C programming language **float** type) data-processing operations.
- Optional instructions for double-precision (C **double** type) data-processing operations.
- Combined Multiply and Accumulate instructions for increased precision (Fused MAC).
- Hardware support for conversion, addition, subtraction, multiplication with optional accumulate, division, and square-root.
- Hardware support for denormals and all IEEE Standard 754-2008 rounding modes.
- 32 32-bit single-precision registers or 16 64-bit double-precision registers.

See [Chapter 8 Floating Point Unit](#) for more information.

1.2.5 Nested Vectored Interrupt Controller

The NVIC is closely integrated with the core to achieve low-latency interrupt processing. Features include:

- External interrupts, configurable from 1 to 240. This is configured at implementation.
- Configurable levels of interrupt priority from 8 to 256. Configured at implementation.
- Dynamic reprioritization of interrupts.
- Priority grouping. This enables selection of preempting interrupt levels and non-preempting interrupt levels.
- Support for tail-chaining and late arrival of interrupts. This enables back-to-back interrupt processing without the overhead of state saving and restoration between interrupts.

See [Chapter 7 Nested Vectored Interrupt Controller](#) for more information.

1.2.6 Wake-up Interrupt Controller

The optional WIC provides ultra-low power sleep mode support.

See [Low power modes on page 7-3](#) for more information.

1.2.7 Memory System

The optional memory system includes:

- A *Bus Interface Unit* (BIU) with a configurable AMBA 4 AXI interface that can support a high-performance L2 memory system.
- An extended AHB-Lite interface to support low-latency system peripherals.
- A *TCM Control Unit* (TCU) with TCM interfaces that can support external ECC logic and an *AHB slave* (AHBS) interface for system access to TCMs.
- Instruction cache and data cache units, with optional *Error Correction Code* (ECC).
- A *Memory Built-in Self Test* (MBIST) interface provided by the *MBIST interface unit* (MIU). The memory system supports online MBIST, where the RAM arrays can be accessed by the MBIST interface while the processor is running. MBIST is also supported during production test.

See [Chapter 5 Memory System](#) for more information.

1.2.8 Store Buffer

The *Store Buffer* (STB) holds store operations when they have left the load/store pipeline and have been committed by the DPU. From the STB, a store can request access to the cache RAM in the DCU, request the BIU to initiate linefills, or request the BIU to write the data out on the AXIM interface.

The STB can merge several store transactions into a single transaction if they are to the same 64-bit aligned address.

1.2.9 Memory Protection Unit

The optional MPU has configurable attributes for memory protection. It includes up to 16 memory regions and *Sub Region Disable* (SRD), enabling efficient use of memory regions. It also has the ability to enable a background region that implements the default memory map attributes. See [Chapter 6 Memory Protection Unit](#) for more information.

1.2.10 Cortex-M7 Processor and PPB ROM tables

The two ROM tables enable a debugger to identify and connect to CoreSight debug components. See [Chapter 9 Debug](#) for more information.

1.2.11 Cross Trigger Interface Unit

The optional CTI enables the debug logic and ETM to interact with each other and with other CoreSight components. See [Chapter 10 Cross Trigger Interface](#).

1.2.12 ETM

The optional ETM provides instruction-only or instruction and data trace capabilities when configured. See the *ARM® CoreSight™ ETM-M7 Technical Reference Manual* for more information.

1.2.13 Debug and trace components

- Configurable *Breakpoint unit* (FPB) for implementing breakpoints.

- Configurable *Data Watchpoint and Trace* (DWT) unit for implementing watchpoints, data tracing, and system profiling.
- Optional ITM for support of `printf()` style debugging, using instrumentation trace.
- Interfaces suitable for:
 - Passing on-chip data to a *Trace Port Analyzer* (TPA), including *Single Wire Output* (SWO) mode.
 - Debugger access to all memory and registers in the system, including access to memory-mapped devices, access to internal core registers when the core is halted, and access to debug control registers even when reset is asserted.

1.3 Interfaces

The processor contains the following external interfaces:

- [AHBP interface](#).
- [AHBS interface](#).
- [AHBD interface](#).
- [External Private Peripheral Bus](#).
- [ATB interfaces](#).
- [TCM interface](#).
- [Cross Trigger interface on page 1-12](#).
- [MBIST interface on page 1-12](#).
- [AXIM interface on page 1-12](#).

1.3.1 AHBP interface

The *AHB-Lite peripheral* (AHBP) interface provides access suitable for low latency system peripherals. It provides support for unaligned memory accesses, write buffer for buffering of write data, and exclusive access transfers for multiprocessor systems. See [AHB peripheral interface on page 5-22](#) for more information.

1.3.2 AHBS interface

The *AHB-Lite slave* (AHBS) interface enables system access to TCMs. See [AHB slave interface on page 5-30](#) for more information.

1.3.3 AHBD interface

The *AHB-Lite Debug* (AHBD) interface provides debug access to the Cortex-M7 processor and the complete memory map. See [About the AHBD interface on page 9-7](#) for more information.

1.3.4 External Private Peripheral Bus

The *APB External PPB* (EPPB) enables access to CoreSight-compatible debug and trace components, in the system connected to the processor.

1.3.5 ATB interfaces

The ATB interfaces output trace information used for debugging. The ATB interface is compatible with the CoreSight architecture. See the *ARM® CoreSight™ Architecture Specification (v2.0)* for more information.

1.3.6 TCM interface

The processor can have up to two TCM memory instances, *Instruction TCM* (ITCM) and *Data TCM* (DTCM), each with a double word data width. Access to ITCM is through the ITCM 64-bit wide interface. Access to DTCM is through the D1TCM 32-bit wide interface and the 32-bit wide D0TCM interface. The DTCM accesses are split so that lower words always access D0TCM and upper words always access D1TCM. The size of both TCM instances is configurable, 4KB-16MB in powers of 2. See [TCM interfaces on page 5-33](#) for more information.

1.3.7 Cross Trigger interface

The processor includes an optional Cross Trigger Interface Unit which includes an interface suitable for connection to external CoreSight components using a Cross Trigger Matrix. See [Chapter 10 Cross Trigger Interface](#) for more information.

1.3.8 MBIST interface

The MBIST interface is used for testing the RAMs during production test. The Cortex-M7 processor also allows the RAMs to be tested using the MBIST interface during normal execution. This is known as online MBIST.

Contact your implementation team for more information about the MBIST interface and online MBIST.

1.3.9 AXIM interface

The *AXI master* (AXIM) interface provides high-performance access to an external memory system. The AXIM interface supports use of the ARM CoreLink L2C-310 Level 2 Cache Controller. L2C-310 Exclusive cache configuration is not supported. See [AXIM interface on page 5-6](#) for more information.

1.4 Supported standards

The processor complies with, or implements, the specifications described in:

- *ARM architecture.*
- *Bus architecture.*
- *Debug.*
- *Embedded Trace Macrocell.*
- *Floating Point Unit.*

This book complements architecture reference manuals, architecture specifications, protocol specifications, and relevant external standards. It does not duplicate information from these sources.

1.4.1 ARM architecture

The Cortex-M7 processor implements the ARMv7E-M architecture profile. See the *ARM®v7-M Architecture Reference Manual*.

The Cortex-M7 processor FPB implements the Flash Patch Breakpoint version 2 architecture revision.

1.4.2 Bus architecture

The processor provides an:

- External interface that is a variant of the AMBA 3 AHB-Lite protocol.
- External interface that complies with the AMBA 4 AXI.

The processor also implements an interface for CoreSight and other debug components using the AMBA 3 APB protocol and AMBA 3 ATB Protocol.

For more information, see:

- The *ARM® AMBA® AXI and ACE Protocol Specification*.
- The *ARM® AMBA® 3 AHB-Lite Protocol (v1.0)*.
- The *ARM® AMBA® 3 APB Protocol Specification*.
- The *ARM® AMBA® 3 ATB Protocol Specification*.

1.4.3 Debug

The debug features of the processor implement the ARM debug interface architecture. See the *ARM® Debug Interface v5 Architecture Specification*.

1.4.4 Embedded Trace Macrocell

When implemented, the trace features of the processor implement the ARM *Embedded Trace Macrocell (ETM)v4* architecture. See the *ARM® Embedded Trace Macrocell Architecture Specification ETMv4*.

1.4.5 Floating Point Unit

Depending on your implementation, a Cortex-M7 processor with FPU can have single-precision only or single and double-precision floating-point data processing as defined by the FPv5 architecture, that is part of the ARMv7E-M architecture. It provides floating-point computation functionality that is compliant with the *ANSI/IEEE Std 754-2008, IEEE Standard for Binary Floating-Point Arithmetic*.

1.5 Design process

The Cortex-M7 processor is delivered as synthesizable RTL that must go through the implementation, integration, and programming processes before you can use it in a product.

The following definitions describe each top-level process in the design flow:

Implementation

The implementer configures and synthesizes the RTL.

Integration

The integrator connects the implemented design into a SoC. This includes connecting it to a memory system and peripherals.

Programming

The system programmer develops the software required to configure and initialize the processor, and tests the required application software.

Each stage in the process can be performed by a different party. Implementation and integration choices affect the behavior and features of the processor.

For MCUs, often a single design team integrates the processor before synthesizing the complete design. Alternatively, the team can synthesize the processor on its own or partially integrated, to produce a macrocell that is then integrated, possibly by a separate team.

The operation of the final device depends on:

Build configuration

The implementer chooses the options that affect how the RTL source files are pre-processed. These options usually include or exclude logic that affects one or more of the area, maximum frequency, and features of the resulting macrocell.

Configuration inputs

The integrator configures some features of the processor by tying inputs to specific values. These configurations affect the start-up behavior before any software configuration is made. They can also limit the options available to the software.

Software configuration

The programmer configures the processor by programming particular values into registers. This affects the behavior of the processor.

Note

This manual refers to implementation-defined features that are applicable to build configuration options. Reference to a feature that is included means that the appropriate build and pin configuration options are selected. Reference to an enabled feature means one that has also been configured by software.

1.6 Documentation

The Cortex-M7 processor documentation can help you complete the top-level processes of implementation, integration, and programming required to use the product correctly.

The Cortex-M7 processor documentation comprises a Technical Reference Manual, an Integration and Implementation Manual, and User Guide Reference Material.

Technical Reference Manual

The *Technical Reference Manual* (TRM) describes the functionality and the effects of functional options on the behavior of the Cortex-M7 processor. It is required at all stages of the design flow. Some behavior described in the TRM might not be relevant because of the way that the Cortex-M7 processor is implemented and integrated. If you are programming the Cortex-M7 processor then contact the implementer to determine:

- The build configuration of the implementation.
- What integration, if any, was performed before implementing the processor.

Integration and Implementation Manual

The *Integration and Implementation Manual* (IIM) describes:

- The available build configuration options and related issues in selecting them.
- How to configure the *Register Transfer Level* (RTL) with the build configuration options.
- How to integrate the processor into a SoC. This includes a description of the integration kit and describes the pins that the integrator must tie off to configure the macrocell for the required integration.
- How to implement the processor into your design. This includes floorplanning guidelines, *Memory Built-in Self Test* (MBIST) and *Design for Test* (DFT) information, and how to perform netlist dynamic verification on the processor.
- The processes to sign off the integration and implementation of the design.

The ARM product deliverables include reference scripts and information about using them to implement your design.

Reference methodology documentation from your EDA tools vendor complements the IIM.

The IIM is a confidential book that is only available to licensees.

User Guide Reference Material

This document provides reference material that ARM partners can configure and include in a User Guide for an ARM Cortex-M7 processor. Typically:

- Each chapter in this reference material might correspond to a section in the User Guide.
- Each top-level section in this reference material might correspond to a chapter in the User Guide.

However, you can organize this material in any way, subject to the conditions of the licence agreement under which ARM supplied the material.

See [Additional reading on page x](#) for more information about the books associated with the Cortex-M7 processor.

1.7 Product revisions

This section describes the differences in functionality between product revisions:

- r0p0** First release.
- r0p1** The following changes have been made in this release:
- Updated CPUID reset value, 0x410FC271.
 - Various engineering errata fixes.
- r0p2** The following changes have been made in this release:
- Updated CPUID reset value, 0x410FC272.
 - Various engineering errata fixes.
- r1p0** The following changes have been made in this release:
- Updated CPUID reset value, 0x411FC270.
 - Added **CTLPPBLOCK[3:0]** to allow locking of registers ITCMCR, DTCMCR, AHBPCR, VTOR to prevent unwanted updates.
 - Added ACTLR bit functions to allow low-capability AXI systems to disable AXI reads to DEV/SO memory and disable exclusive reads/writes to shared memory not initiated until all outstanding reads/stores on AXI are complete.
 - Added **MBISTIMPERR[2]** output to MBIST interface to provide an error when attempting to access unimplemented memory.
 - Improved handling of simultaneous AHBS and software activity relating to the same TCM.
- r1p1** The following changes have been made in this release:
- Updated CPUID reset value, 0x411FC271.

Chapter 2

Programmers Model

This chapter describes the programmers model. It contains the following sections:

- *About the programmers model* on page 2-2.
- *Modes of operation and execution* on page 2-3.
- *Instruction set summary* on page 2-4.
- *System address map* on page 2-5.
- *Exclusive monitor* on page 2-7.
- *Processor core registers* on page 2-8.
- *Exceptions* on page 2-9.

2.1 About the programmers model

This chapter gives an overview of the Cortex-M7 processor programmers model that describes the implementation-defined options. In addition:

- [Chapter 3](#) summarizes the system control features of the programmers model.
- [Chapter 6](#) summarizes the MPU features of the programmers model.
- [Chapter 7](#) summarizes the NVIC features of the programmers model.
- [Chapter 8](#) summarizes the FPU features of the programmers model.
- [Chapter 9](#) summarizes the Debug features of the programmers model.
- [Chapter 10](#) summarizes the CTI features of the programmers model.
- [Chapter 11](#) summarizes the DWT features of the programmers model.
- [Chapter 12](#) summarizes the ITM features of the programmers model.

2.2 Modes of operation and execution

This section briefly describes the modes of operation and execution of the Cortex-M7 processor. See the *ARM[®]v7-M Architecture Reference Manual* for more information.

2.2.1 Operating modes

The processor supports two modes of operation, Thread mode and Handler mode:

- The processor enters Thread mode on reset, or as a result of an exception return. Privileged and Unprivileged code can run in Thread mode.
- The processor enters Handler mode as a result of an exception. All code is privileged in Handler mode.

2.2.2 Operating states

The processor can operate in one of two operating states:

- Thumb state. This is normal execution running 16-bit and 32-bit halfword-aligned Thumb instructions.
- Debug state. This is the state when the processor is in halting debug.

2.2.3 Privileged access and unprivileged User access

Code can execute as privileged or unprivileged. Unprivileged execution limits or excludes access to some resources. Privileged execution has access to all resources. Handler mode is always privileged. Thread mode can be privileged or unprivileged.

2.3 Instruction set summary

The processor implements the ARMv7-M instruction set and features provided by the ARMv7E-M architecture profile. For more information about the ARMv7-M instructions, see the *ARM[®]v7-M Architecture Reference Manual*.

2.3.1 Binary compatibility with other Cortex processors

The processor is binary compatible with the instruction sets and features implemented in other Cortex-M profile processors. You cannot move software from the Cortex-M7 processor to:

- The Cortex-M3 processor if it contains floating-point operations or instructions that are part of the DSP extension, such as SADD16.
- The Cortex-M4 processor if it contains double-precision floating-point operations.
- The Cortex-M0 or Cortex-M0+ processors because these are implementations of the ARMv6-M Architecture.

Code designed for the Cortex-M3 and Cortex-M4 processors is compatible with the Cortex-M7 processor as long as it does not rely on bit-banding.

To ensure a smooth transition when migrating software to the Cortex-M7 processor, ARM recommends that code designed to operate on the Cortex-M0, M0+, M3, and M4 processors obey the following rules and that you configure the *Configuration and Control Register (CCR)* appropriately:

- Use word transfers only to access registers in the NVIC and *System Control Space (SCS)*.
- Treat all unused SCS registers and register fields on the processor as Do-Not-Modify.
- Configure the following fields in the CCR:
 - STKALIGN bit to 1.
 - UNALIGN_TRP bit to 1.
 - Leave all other bits in the CCR register at their original value.

2.4 System address map

The processor contains an internal bus matrix that arbitrates the processor and external AHBD memory accesses to both the external memory system and to the internal SCS and debug components.

Priority is always given to the processor to ensure that any debug accesses are as non-intrusive as possible.

Figure 2-1 shows the system address map.

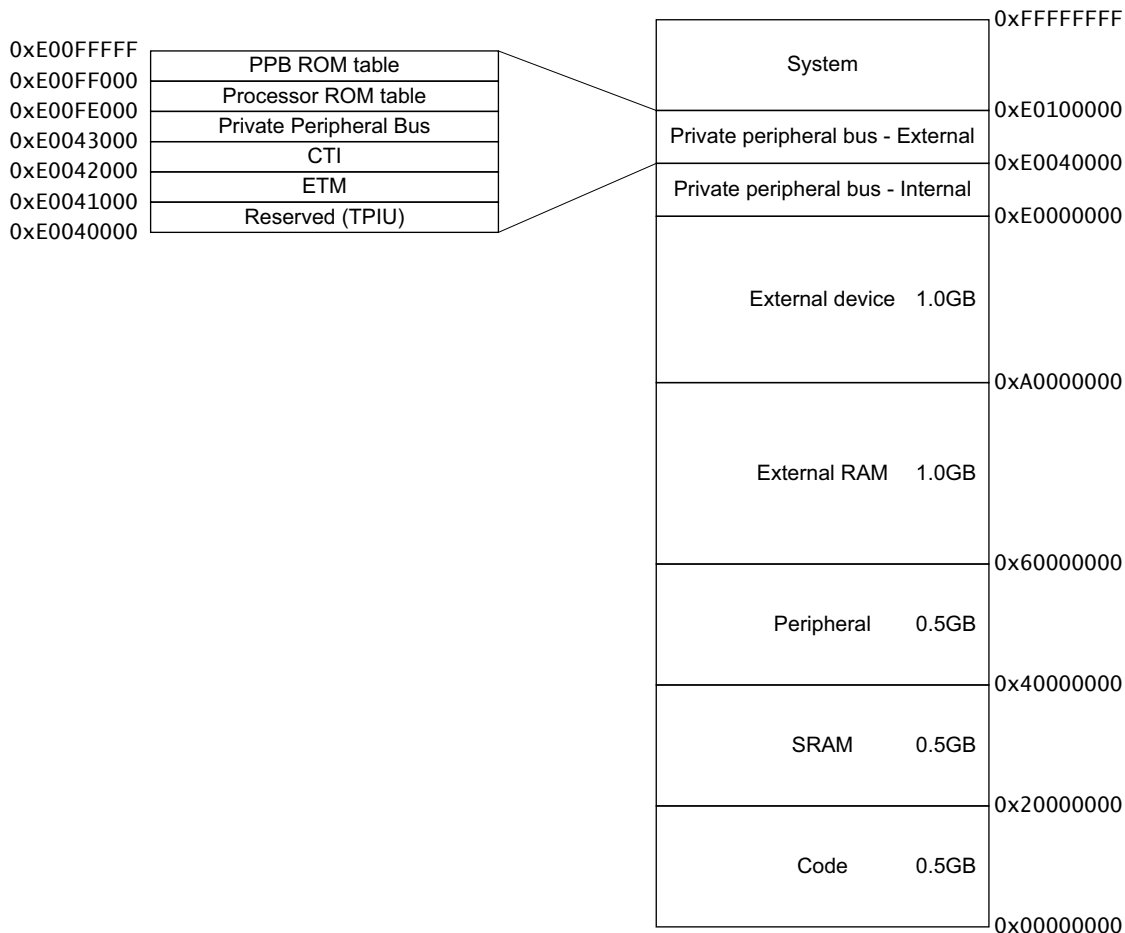

Figure 2-1 System address map

Table 2-1 shows the processor interfaces that are addressed by the different memory map regions.

Table 2-1 Memory regions

Memory Map	Region
Code	Instruction fetches and data accesses are performed over the ITCM or AXIM interface.
SRAM	Instruction fetches and data accesses are performed over the DTCM or AXIM interface.
Peripheral	Data accesses are performed over the AHBP or AXIM interface. Instruction fetches are performed over the AXIM interface.
External RAM	Instruction fetches and data accesses are performed over the AXIM interface.

Table 2-1 Memory regions (continued)

Memory Map	Region
External Device	Instruction fetches and data accesses are performed over the AXIM interface.
Private Peripheral Bus	Data accesses to registers associated with peripherals outside the processor are performed on the <i>External Private Peripheral Bus</i> (EPPB) interface. See <i>Private peripheral bus</i> . This memory region is <i>Execute Never</i> (XN), and so instruction fetches are prohibited. An MPU, if present, cannot change this.
System	System segment for vendor system peripherals. Data accesses are performed over the AHBP interface. This memory region is XN, and so instruction fetches are prohibited. An MPU, if present, cannot change this.

See the *ARM[®]v7-M Architecture Reference Manual* for more information about the memory model.

2.4.1 Private peripheral bus

The internal PPB interface provides access to:

- The *Instrumentation Trace Macrocell* (ITM).
- The *Data Watchpoint and Trace* (DWT).
- The *Breakpoint unit* (FPB).
- The SCS, including the MPU, the instruction and data cache, and the *Nested Vectored Interrupt Controller* (NVIC).
- The Processor and PPB ROM tables.

The external PPB interface provides access to:

- The *Embedded Trace Macrocell* (ETM).
- The *Cross Trigger Interface* (CTI).
- CoreSight debug and trace components in the external system.

2.4.2 Unaligned accesses that cross regions

The Cortex-M7 processor supports ARMv7 unaligned accesses, and performs all accesses as single, unaligned accesses. They are converted into two or more aligned accesses internally and are performed on the external interfaces of the processor.

———— **Note** —————

All Cortex-M7 processor external accesses are aligned.

Unaligned support is only available for load/store singles (LDR, LDRH, STR, STRH). Load/store double already supports word aligned accesses, but does not permit other unaligned accesses, and generates a fault if this is attempted.

Unaligned accesses that cross memory map boundaries are architecturally UNPREDICTABLE. The processor behavior is boundary dependent. Unaligned accesses are not supported to PPB space, and so there are no boundary crossing cases for PPB accesses.

2.5 Exclusive monitor

The Cortex-M7 processor implements a local exclusive monitor. For more information about semaphores and the local exclusive monitor see the *ARM[®]v7-M Architecture Reference Manual*.

The local monitor within the processor is constructed so that it does not hold any physical address. Instead it treats any access as matching the address of the previous LDREX instruction. This means that the implemented *Exclusives Reservation Granule* (ERG) is the entire memory address range.

2.6 Processor core registers

The processor has the following 32-bit registers:

- 13 general-purpose registers, R0-R12.
- *Stack Pointer* (SP), R13 alias of banked registers, SP_process and SP_main.
- *Link Register* (LR), R14.
- *Program Counter* (PC), R15.
- Special-purpose *Program Status Registers* (xPSR).

For more information about the processor register set, see the *ARM[®]v7-M Architecture Reference Manual*.

2.7 Exceptions

The processor and the NVIC prioritize and handle all exceptions. When handling exceptions:

- All exceptions are handled in Handler mode.
- Processor state is automatically stored to the stack on an exception, and automatically restored from the stack at the end of the *Interrupt Service Routine* (ISR).
- The vector is fetched in parallel to the state saving, enabling efficient interrupt entry.

The processor supports tail-chaining that enables back-to-back interrupts without the overhead of state saving and restoration.

You configure the number of interrupts, and levels of interrupt priority, during implementation. Software can choose only to enable a subset of the configured number of interrupts, and can choose how many levels of the configured priorities to use.

Note

The EPSR.T bit supports the ARM architecture interworking model, however, as ARMv7-M only supports execution of Thumb instructions, it must always be maintained with the value 1. This means that all exception vectors must have bit[0] set. If bit[0] of the associated vector table entry is set to 0 on exception entry, execution of the first instruction causes an INVSTATE UsageFault. If this happens on a reset, this escalates to a HardFault, because UsageFault is disabled on reset.

2.7.1 Exception handling

External read faults from either the TCM interfaces, the AXIM interface, or the AHB interfaces generate a synchronous exception in the processor. External write faults generate an asynchronous exception in the processor.

The processor implements advanced exception and interrupt handling, as described in the *ARM[®]v7-M Architecture Reference Manual*.

The processor exception model has the following implementation-defined behavior in addition to the architecturally-defined behavior:

- Exceptions on stacking from HardFault to NMI lockup at NMI priority.
- Exceptions on unstacking from NMI to HardFault lockup at HardFault priority.

To minimize interrupt latency, the processor can abandon the majority of multicycle instructions that are executing when an interrupt is recognized. The only exception is a load from Device or Strongly-ordered memory, or a shared store exclusive operation that starts on the AXI interface. All normal memory transactions are abandoned when an interrupt is recognized.

The processor restarts any abandoned operation on return from the interrupt. The processor also implements the Interruptible-continuable bits allowing load and store multiples to be interruptible and continuable. In these cases the processor resumes execution of these instructions after the last completed transfer instead of from the start. For more information on the Interruptible-continuable bits and key limitations on when they apply, see the *ARM[®]v7-M Architecture Reference Manual*.

Specifically, on the Cortex-M7 processor, these instructions always restart instead of continue:

- The instruction faults.
- The instruction is inside an *If-Then* (IT) block.
- The instruction is a load multiple, has the base register in the list and has loaded the base register.
- The instruction is a load multiple and is subject to an ECC error.

Chapter 3

System Control

This chapter describes the registers that program the processor. It contains the following sections:

- *About system control* on page 3-2.
- *Register summary* on page 3-3.
- *Register descriptions* on page 3-6.

3.1 About system control

This chapter describes the registers that control the operation of the processor. This includes registers in the:

- System Control Space.
- Access Control Space.
- Identification Space.
- Cache Maintenance Space.

3.2 Register summary

Table 3-1 shows the system control registers. Registers not described in this chapter are described in the *ARM[®]v7-M Architecture Reference Manual*.

Table 3-1 System control registers

Address	Name	Type	Reset	Description
0xE000E008	ACTLR	RW	0x00000000	<i>Auxiliary Control Register on page 3-6</i>
0xE000E00C	-	-	-	Reserved
0xE000E010	SYST_CSR	RW	0x00000000	SysTick Control and Status Register
0xE000E014	SYST_RVR	RW	Unknown	SysTick Reload Value Register
0xE000E018	SYST_CVR	RW	Unknown	SysTick Current Value Register
0xE000E01C	SYST_CALIB	RO	..a	SysTick Calibration Value Register
0xE000ED00	CPUID	RO	0x411FC271	<i>CPUID Base Register on page 3-8</i>
0xE000ED04	ICSR	RW or RO	0x00000000	Interrupt Control and State Register
0xE000ED08	VTOR	RW	..b	Vector Table Offset Register
0xE000ED0C	AIRCR	RW	0xFA050000 ^c	Application Interrupt and Reset Control Register
0xE000ED10	SCR	RW	0x00000000	System Control Register
0xE000ED14	CCR	RW ^d	0x00040200	Configuration and Control Register
0xE000ED18	SHPR1	RW	0x00000000	System Handler Priority Register 1
0xE000ED1C	SHPR2	RW	0x00000000	System Handler Priority Register 2
0xE000ED20	SHPR3	RW	0x00000000	System Handler Priority Register 3
0xE000ED24	SHCSR	RW	0x00000000	System Handler Control and State Register
0xE000ED28	CFSR	RW	0x00000000	Configurable Fault Status Registers ^e
0xE000ED2C	HFSR	RW	0x00000000	HardFault Status Register
0xE000ED30	DFSR	RW	0x00000000	Debug Fault Status Register
0xE000ED34	MMFAR	RW	Unknown	MemManage Fault Address Register ^f
0xE000ED38	BFAR	RW	Unknown	BusFault Address Register ^f
0xE000ED40	ID_PFR0	RO	0x00000030	Processor Feature Register 0
0xE000ED44	ID_PFR1	RO	0x00000200	Processor Feature Register 1
0xE000ED48	ID_DFR0	RO	0x00100000	Debug Feature Register 0 ^g
0xE000ED4C	ID_AFR0	RO	0x00000000	Auxiliary Feature Register 0
0xE000ED50	ID_MMFR0	RO	0x00100030 ^h	Memory Model Feature Register 0
0xE000ED54	ID_MMFR1	RO	0x00000000	Memory Model Feature Register 1
0xE000ED58	ID_MMFR2	RO	0x01000000	Memory Model Feature Register 2
0xE000ED5C	ID_MMFR3	RO	0x00000000	Memory Model Feature Register 3

Table 3-1 System control registers (continued)

Address	Name	Type	Reset	Description
0xE000ED60	ID_ISAR0	RO	0x01101110	Instruction Set Attributes Register 0
0xE000ED64	ID_ISAR1	RO	0x02112000	Instruction Set Attributes Register 1
0xE000ED68	ID_ISAR2	RO	0x20232231	Instruction Set Attributes Register 2
0xE000ED6C	ID_ISAR3	RO	0x01111131	Instruction Set Attributes Register 3
0xE000ED70	ID_ISAR4	RO	0x01310132	Instruction Set Attributes Register 4
0xE000ED78	CLIDR	RO	i	<i>Cache Level ID Register on page 3-9</i>
0xE000ED7C	CTR	RO	0x8303C003	Cache Type Register
0xE000ED80	CCSIDR	RO	j	<i>Cache Size ID Register on page 3-10</i>
0xE000ED84	CSSELR	RW	UNPREDICTABLE	<i>Cache Size Selection Register on page 3-12</i>
0xE000ED88	CPACR	RW	-	Coprocessor Access Control Register
0xE000EF00	STIR	WO	0x00000000	Software Triggered Interrupt Register
0xE000EF50	ICIALLU	WO	Unknown	Instruction cache invalidate all to <i>Point of Unification (PoU)</i>
0xE000EF54	-	-	-	Reserved
0xE000EF58	ICIMVAU	WO	Unknown	Instruction cache invalidate by address to PoU
0xE000EF5C	DCIMVAC	WO	Unknown	Data cache invalidate by address to <i>Point of Coherency (PoC)</i>
0xE000EF60	DCISW	WO	Unknown	Data cache invalidate by set/way
0xE000EF64	DCCMVAU	WO	Unknown	Data cache by address to PoU
0xE000EF68	DCCMVAC	WO	Unknown	Data cache clean by address to PoC
0xE000EF6C	DCCSW	WO	Unknown	Data cache clean by set/way
0xE000EF70	DCCIMVAC	WO	Unknown	Data cache clean and invalidate by address to PoC
0xE000EF74	DCCISW	WO	Unknown	Data cache clean and invalidate by set/way
0xE000EF78	BPIALL	RAZ/WI	Unknown	Not implemented
0xE000EF7C	-	-	-	Reserved
0xE000EF80	-	-	-	Reserved
0xE000EF90	CM7_ITCMCR	RW	Unknown	<i>Instruction and Data Tightly-Coupled Memory Control Registers on page 3-13</i>
0xE000EF94	CM7_DTCMCR	RW	Unknown	
0xE000EF98	CM7_AHBPCR	RW	Unknown	<i>AHBP Control Register on page 3-14</i>
0xE000EF9C	CM7_CACR	RW	Unknown	<i>L1 Cache Control Register on page 3-15</i>
0xE000EFA0	CM7_AHBSCR	RW	Unknown	<i>AHB Slave Control Register on page 3-20</i>
0xE000EFA4	-	-	-	Reserved
0xE000EFA8	CM7_ABFSR	RW	Unknown	<i>Auxiliary Bus Fault Status Register on page 3-16</i>

Table 3-1 System control registers (continued)

Address	Name	Type	Reset	Description
0xE000EFB0	IEBR0 ^k	RW	-	<i>Instruction Error bank Register 0-1 on page 3-17</i>
0xE000EFB4	IEBR1 ^k	RW	-	
0xE000EFB8	DEBR0 ^k	RW	-	<i>Data Error bank Register 0-1 on page 3-18</i>
0xE000EFBC	DEBR1 ^k	RW	-	
0xE000EFD0	PID4	-	0x00000004	See the <i>Component and Peripheral ID register formats</i> in the <i>ARM[®]v7-M Architecture Reference Manual</i> .
0xE000EFD4	PID5	-	0x00000000	
0xE000EFD8	PID6	-	0x00000000	
0xE000EFD4	PID7	-	0x00000000	
0xE000EFE0	PID0	-	_1	
0xE000EFE4	PID1	-	0x000000B0	
0xE000EFE8	PID2	-	0x000000B8	
0xE000EFEC	PID3	-	0x000000C0	
0xE000EFF0	CID0	-	0x000000D0	
0xE000EFF4	CID1	-	0x000000E0	
0xE000EFF8	CID2	-	0x000000F0	
0xE000EFFF	CID3	-	0x00000100	

- a. SYST_CALIB indicates the value of signal **CFGSTCALIB[25:0]**. See [Table 3-2](#).
- b. VTOR[31:7] indicates the value of signal **INITVTOR[31:7]**. VTOR[6:0] are RAZ.
- c. AIRCR[15] indicates the value of signal **CFGBIGEND**.
- d. The processor implements bit[9] of CCR, STKALIGN, as RO and has a value of 1.
- e. The 32-bit CFSR comprises the status registers for the faults that have configurable priority. Software can access the combined CFSR, or use byte or halfword accesses to access the individual registers, *MemManage Status Register* (MMFSR), *BusFault Status Register* (BFSR), and *UsageFault Status Register* (UFSR). See the *ARM[®]v7-M Architecture Reference Manual* for more information.
- f. BFAR and MFAR are the same physical register. Because of this, the BFARVALID and MFARVALID bits are mutually exclusive.
- g. ID_DFR0 reads as 0 if no debug support is implemented.
- h. The reset value depends on the values of signals **CFGITCMSZ** and **CFGDTCMSZ**.
- i. The reset value depends on whether L1 cache is implemented.
- j. Reset value depends on which caches are implemented and their sizes.
- k. Only present if ECC is present, otherwise RAZ/WI.
- l. This value is 0x00000000 for implementations without FPU or 0x0000000C for implementations with FPU.

[Table 3-2](#) shows how signal **CFGSTCALIB[25:0]** is indicated in register SYST_CALIB.

Table 3-2 SYST_CALIB inputs

Bits	Name	Input
[31]	NOREF	CFGSTCALIB[25] .
[30]	SKEW	CFGSTCALIB[24] .
[29:24]	-	None. RAZ.
[23:0]	TENMS	CFGSTCALIB[23:0] .

3.3 Register descriptions

This section describes the following system control registers whose implementation is specific to this processor:

- *Auxiliary Control Register.*
- *CPUID Base Register on page 3-8.*
- *Cache Level ID Register on page 3-9.*
- *Cache Size ID Register on page 3-10.*
- *Cache Size Selection Register on page 3-12.*
- *Instruction and Data Tightly-Coupled Memory Control Registers on page 3-13.*
- *AHBP Control Register on page 3-14.*
- *L1 Cache Control Register on page 3-15.*
- *Auxiliary Bus Fault Status Register on page 3-16.*
- *Instruction Error bank Register 0-1 on page 3-17.*
- *Data Error bank Register 0-1 on page 3-18.*
- *AHB Slave Control Register on page 3-20.*

3.3.1 Auxiliary Control Register

The ACTLR characteristics are:

Purpose Provides implementation defined configuration and control options for the processor.

Usage Constraints There are no usage constraints.

Configurations Available in all configurations.

Attributes See the register summary in [Table 3-1 on page 3-3](#).

[Figure 3-1](#) shows the ACTLR bit assignments.

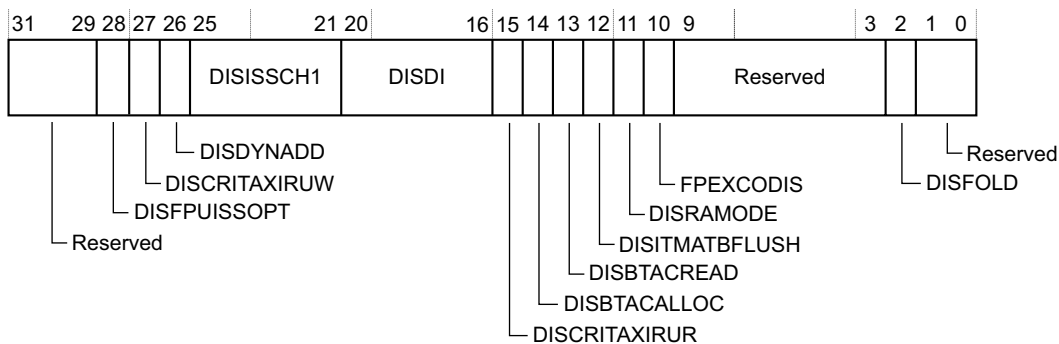

Figure 3-1 ACTLR bit assignments

Table 3-3 shows the ACTLR bit assignments.

Table 3-3 ACTLR bit assignments

Bits	Name	Function
[31:29]	-	Reserved.
[28]	DISFPUISSOPT	0 Normal operation.
[27]	DISCRITAXIRUW	Disable critical AXI read-under-write: 0 Normal operation. This is backwards compatible with r0. 1 AXI reads to DEV/SO memory. Exclusive reads to shared memory are not initiated on the AXIM AR channel until all outstanding stores on AXI are complete.
[26]	DISDYNADD	Disables dynamic allocation of ADD and SUB instructions: 0 Normal operation. Some ADD and SUB instructions are resolved in EX1. 1 All ADD and SUB instructions are resolved in EX2.
[25:21]	DISISSCH1	0 Normal operation. 1 Instruction type might not be issued in channel 1. [25] VFP. [24] Integer MAC and MUL. [23] Loads to PC. [22] Indirect branches, but not loads to PC. [21] Direct branches.
[20:16]	DISDI	0 Normal operation. 1 Nothing can be dual-issued when this instruction type is in channel 0. [20] VFP. [19] Integer MAC and MUL. [18] Loads to PC. [17] Indirect branches, but not loads to PC. [16] Direct branches.
[15]	DISCRITAXIRUR	Disables critical AXI Read-Under-Read. 0 Normal operation. 1 An AXI read to Strongly-ordered or Device memory, or an LDREX to shared memory, is not put on AXI if there are any outstanding reads on AXI. Transactions on AXI cannot be interrupted. This bit might reduce the time that these transactions are in progress and might improve worst case interrupt latency. Performance is decreased when this bit is set.
[14]	DISBTACALLOC	0 Normal operation. 1 No new entries are allocated in <i>Branch Target Address Cache</i> (BTAC), but existing entries can be updated.
[13]	DISBTACREAD	0 Normal operation. 1 BTAC is not used and only static branch prediction can occur.
[12]	DISITMATBFLUSH	Disables ITM and DWT ATB flush: 1 ITM and DWT ATB flush disabled. AFVALID is ignored and AFREADY is held HIGH.

Note

This bit is always 1 and therefore RO/WI.

Table 3-3 ACTLR bit assignments (continued)

Bits	Name	Function
[11]	DISRAMODE	Disables dynamic read allocate mode for Write-Back Write-Allocate memory regions: 0 Normal operation. 1 Dynamic disabled.
[10]	FPEXCODIS	Disables FPU exception outputs. 0 Normal operation. 1 FPU exception outputs are disabled.
[9:3]	-	Reserved.
[2]	DISFOLD	0 Normal operation.
[1:0]	-	Reserved.

3.3.2 CPUID Base Register

The CPUID characteristics are:

- Purpose** Specifies:
- The ID number of the processor core.
 - The version number of the processor core.
 - The implementation details of the processor core.

Usage Constraints There are no usage constraints.

Configurations Available in all configurations.

Attributes See the register summary in [Table 3-1 on page 3-3](#).

[Figure 3-2](#) shows the CPUID bit assignments.

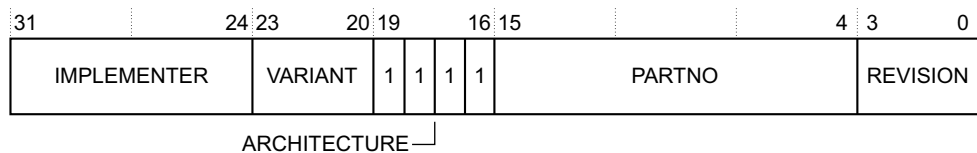

Figure 3-2 CPUID bit assignments

[Table 3-4](#) shows the CPUID bit assignments.

Table 3-4 CPUID bit assignments

Bits	Name	Function
[31:24]	IMPLEMENTER	Indicates implementer: 0x41 ARM.
[23:20]	VARIANT	Indicates processor revision: 0x0 Revision 0. 0x1 Revision 1.

Table 3-4 CPUID bit assignments (continued)

Bits	Name	Function
[19:16]	ARCHITECTURE	Reads as 0xF.
[15:4]	PARTNO	Indicates part number: 0xC27 Cortex-M7.
[3:0]	REVISION	Indicates patch release: 0x0 Patch 0. 0x1 Patch 1. 0x2 Patch 2.

Note

See [Product revisions on page 1-16](#) for the different Cortex-M7 processor revisions and the combinations of the VARIANT and REVISION bit fields used.

3.3.3 Cache Level ID Register

The CLIDR Register characteristics are:

- Purpose**
- Indicates the cache levels that are implemented. Architecturally, there can be a different number of cache levels on the instruction and data side.
 - Captures the point-of-coherency.
 - Captures the point-of-unification.
- Usage constraints** The CLIDR is:
- A read-only register.
 - Accessible in Privileged mode only.
- Configurations** Available in all processor configurations.
- Attributes** See the register summary in [Table 3-5 on page 3-10](#).

[Figure 3-3](#) shows the CLIDR bit assignments.

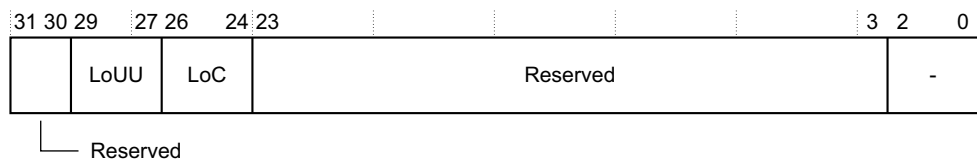

Figure 3-3 CLIDR bit assignments

Table 3-5 shows the CLIDR bit assignments.

Table 3-5 CLIDR bit assignments

Bits	Name	Function
[31:30]	-	Reserved.
[29:27]	LoUU	Level of Unification Uniprocessor: 0b001 Level 2, if either cache is implemented. 0b000 Level 1, if neither instruction nor data cache is implemented.
[26:24]	LoC	Level of Coherency: 0b001 Level 2, if either cache is implemented. 0b000 Level 1, if neither instruction nor data cache is implemented.
[23:3]	-	Reserved.
[2:0]	-	Level 1 cache type: 0b001 Instruction cache is implemented. 0b010 Data cache is implemented. 0b011 Instruction and data cache are implemented. 0b000 No instruction or data cache are implemented.

3.3.4 Cache Size ID Register

The CCSIDR characteristics are:

Purpose	Provides information about the size and behavior of the instruction or data cache selected by the CSSELR. Architecturally, there can be up to eight levels of cache, containing instruction, data, or unified caches. This processor contains L1 instruction and data caches only.
Usage constraints	The CCSIDR is: <ul style="list-style-type: none"> • A read-only register. • Accessible in Privileged mode only.
Configurations	Available in all processor configurations. If no instruction or data cache is configured, the corresponding CCSIDR is RAZ.
Attributes	See the register summary in Table 3-6 on page 3-11 .

Figure 3-4 shows the CCSIDR bit assignments.

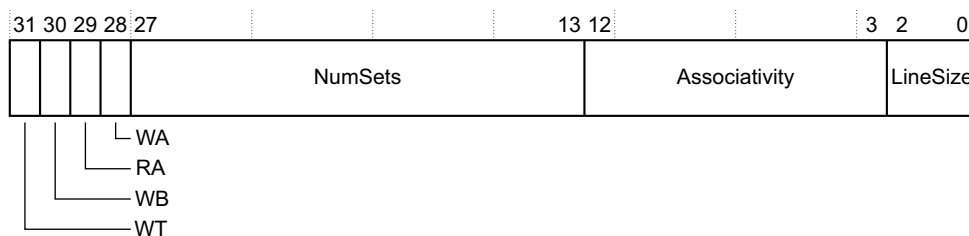

Figure 3-4 CCSIDR bit assignments

Table 3-6 shows the CCSIDR bit assignments.

Table 3-6 CCSIDR bit assignments

Bits	Name	Function ^a
[31]	WT	Indicates support available for Write-Through: 1 Write-Through support available.
[30]	WB	Indicates support available for Write-Back: 1 Write-Back support available.
[29]	RA	Indicates support available for read allocation: 1 Read allocation support available.
[28]	WA	Indicates support available for write allocation: 1 Write allocation support available.
[27:13]	NumSets	Indicates the number of sets as: (number of sets) - 1. Cache-size dependent.
[12:3]	Associativity	Indicates the number of ways as: (number of ways) - 1. 0x1 Represents two instruction caches. 0x3 Represents four data caches.
[2:0]	LineSize	Indicates the number of words in each cache line. 0x1 Represents 32 bytes.

a. See Table 3-7 for valid bit field encodings.

The LineSize field is encoded as 2 less than \log_2 of the number of words in the cache line. For example, a value of 0x0 indicates there are four words in a cache line, that is the minimum size for the cache. A value of 0x1 indicates there are eight words in a cache line.

Table 3-7 shows the individual bit field and complete register encodings for the CCSIDR. Use this to determine the cache size for the L1 data or instruction cache selected by the *Cache Size Selection Register* (CSSELR). See *Cache Size Selection Register* on page 3-12.

Table 3-7 CCSIDR encodings

CSSELR	Cache	Size	Complete register encoding	Register bit field encoding						
				WT	WB	RA	WA	NumSets	Associativity	LineSize
0x0	Data cache	4KB	0xF003E019	1	1	1	1	0x001F	0x3	0x1
		8KB	0xF007E019					0x003F		
		16KB	0xF00FE019					0x007F		
		32KB	0xF01FE019					0x00FF		
		64KB	0xF03FE019					0x01FF		

Table 3-7 CCSIDR encodings (continued)

CSSELR	Cache	Size	Complete register encoding	Register bit field encoding						
				WT	WB	RA	WA	NumSets	Associativity	LineSize
0x1	Instruction cache	4KB	0xF007E009	1	1	1	1	0x003F	0x1	0x1
		8KB	0xF00FE009					0x007F		
		16KB	0xF01FE009					0x00FF		
		32KB	0xF03FE009					0x01FF		
		64KB	0xF07FE009					0x03FF		

3.3.5 Cache Size Selection Register

The CSSELR characteristics are:

Purpose Holds the value that the processor uses to select the CSSELR to use.

Usage constraints The CSSELR is:

- A read/write register.
- Accessible in Privileged mode only.

Configurations Available in all processor configurations.

Attributes See the register summary in [Table 3-8](#).

[Figure 3-5](#) shows the CSSELR bit assignments.

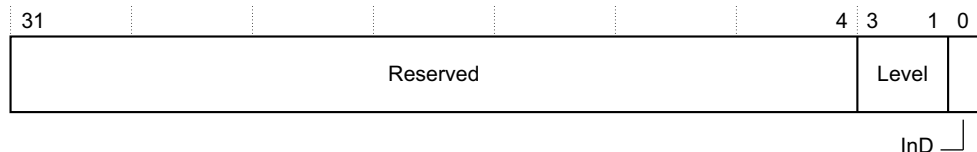

Figure 3-5 CSSELR bit assignments

[Table 3-8](#) shows the CSSELR bit assignments.

Table 3-8 CSSELR bit assignments

Bits	Name	Function
[31:4]	-	Reserved.
[3:1]	Level	Identifies which cache level to select. 0b000 Level 1 cache. This field is RAZ/WI.
[0]	InD	Selects either instruction or data cache. 0 Data cache. 1 Instruction cache.

3.3.6 Instruction and Data Tightly-Coupled Memory Control Registers

The CM7_ITCMCR and CM7_DTCMCR characteristics are:

Purpose Controls whether an access is mapped to TCM or AXIM interface.

Usage Constraints Accessible in privileged mode only.

Configurations Available in all configurations.

Attributes See the register summary in [Table 3-1 on page 3-3](#).

[Figure 3-6](#) shows the CM7_ITCMCR and CM7_DTCMCR bit assignments.

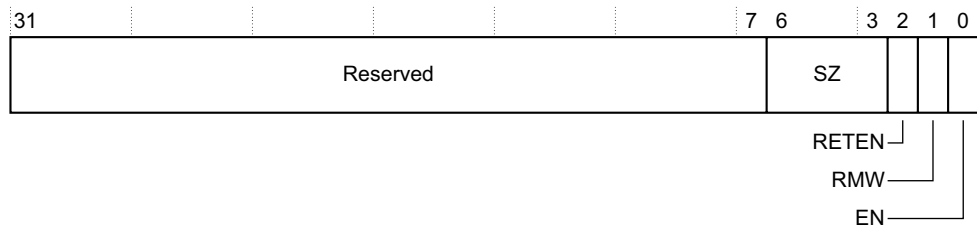

Figure 3-6 CM7_ITCMCR and CM7_DTCMCR bit assignments

[Table 3-9](#) shows the CM7_ITCMCR and CM7_DTCMCR bit assignments.

Table 3-9 CM7_ITCMCR and CM7_DTCMCR bit assignments

Bits	Name	Type	Function
[31:7]	-	-	Reserved.
[6:3]	SZ	RO	TCM size. Indicates the size of the relevant TCM: 0b0000 No TCM implemented. 0b0011 4KB. 0b0100 8KB. 0b0101 16KB. 0b0110 32KB. 0b0111 64KB. 0b1000 128KB. 0b1001 256KB. 0b1010 512KB. 0b1011 1MB. 0b1100 2MB. 0b1101 4MB. 0b1110 8MB. 0b1111 16MB.

All other encodings are reserved. The reset value is derived from the **CFGITCMSZ** and **CFGDTCMSZ** pins.

Table 3-9 CM7_ITCMCR and CM7_DTCMCR bit assignments (continued)

Bits	Name	Type	Function
[2]	RETEN	RW	<p>Retry phase enable. When enabled the processor guarantees to honor the retry output on the corresponding TCM interface, re-executing the instruction that performed the TCM access.</p> <p>0 Retry phase disabled. 1 Retry phase enabled.</p> <p>The reset value is derived from the INITRETRYEN pin. The retry functionality can be used together with external logic to support error detection and correction in the TCM.</p>
[1]	RMW	RW	<p><i>Read-Modify-Write</i> (RMW) enable. Indicates that all writes to TCM, that are not the full width of the TCM RAM, use a RMW sequence:</p> <p>0 RMW disabled. 1 RMW enabled.</p> <p>The reset value is derived from the INITRMWEN pin. The RMW functionality can be used together with external logic to support error detection and correction in the TCM.</p>
[0]	EN	RW	<p>TCM enable. When a TCM is disabled all accesses are made to the AXIM interface.</p> <p>0 TCM disabled. 1 TCM enabled.</p> <p>The reset value is derived from the INITTCMEN pin.</p>

3.3.7 AHBP Control Register

The CM7_AHBPCR characteristics are:

Purpose Controls accesses to AHBP or AXIM interface.

Usage Constraints Accessible in privileged mode only.

Configurations Available in all configurations.

Attributes See the register summary in [Table 3-1 on page 3-3](#).

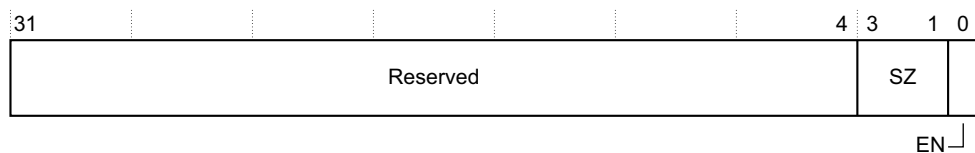

Figure 3-7 CM7_AHBPCR bit assignments

Table 3-10 shows the CM7_AHBPCR bit assignments.

Table 3-10 CM7_AHBPCR bit assignments

Bits	Name	Type	Function
[31:4]	-	-	Reserved.
[3:1]	SZ	RO	AHBP size: 0b000 0MB. AHBP disabled. 0b001 64MB. 0b010 128MB. 0b011 256MB. 0b100 512MB. Other encodings are reserved. Reset values comes from the CFGAHBPSZ pins.
[0]	EN	RW	AHBP enable: 0 AHBP disabled. When disabled all accesses are made to the AXIM interface. 1 AHBP enabled. The reset value is derived from the INITAHBPEN pins.

3.3.8 L1 Cache Control Register

The CM7_CACR characteristics are:

Purpose Controls the L1 ECC and the L1 cache coherency usage model.

Usage Constraints Accessible in privileged mode only.

Configurations Available in all configurations.

Attributes See the register summary in [Table 3-1 on page 3-3](#).

[Figure 3-8](#) shows the CM7_CACR bit assignments.

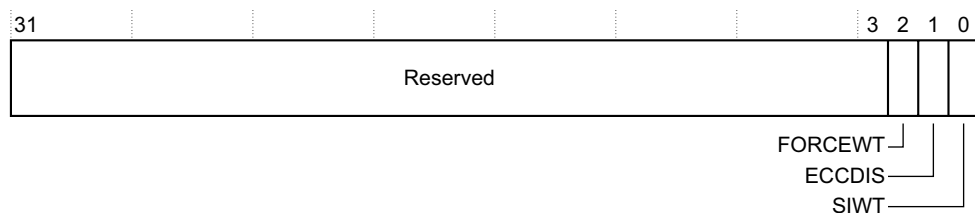

Figure 3-8 CM7_CACR bit assignments

Table 3-11 shows the CM7_CACR bit assignments.

Table 3-11 CM7_CACR bit assignments

Bits	Name	Type	Function
[31:3]	-	-	Reserved, RAZ/WI.
[2]	FORCEWT	RW	<p>Enables Force Write-Through in the data cache:</p> <p>0 Disables Force Write-Through.</p> <p>1 Enables Force Write-Through. All Cacheable memory regions are treated as Write-Through.</p> <p>This bit is RAZ/WI if the data cache is excluded. If the data cache is included the reset value of FORCEWT is 0.</p>
[1]	ECCDIS	RW	<p>Enables ECC in the instruction and data cache:</p> <p>0 Enables ECC in the instruction and data cache. This is RAO/WI if both data cache and instruction cache are excluded or if ECC is excluded.</p> <p>1 Disables ECC in the instruction and data cache. This is RAZ/WI if data cache is not configured.</p>
[0]	SIWT	RW	<p>Shared cacheable-is-WT for data cache. Enables limited cache coherency usage:</p> <p>0 Normal Cacheable Shared locations are treated as being Non-cacheable. Programmed inner cacheability attributes are ignored. This is the default mode of operation for Shared memory. The data cache is transparent to software for these locations and therefore no software maintenance is required to maintain coherency.</p> <p>1 Normal Cacheable shared locations are treated as Write-Through. Programmed inner cacheability attributes are ignored. All writes are globally visible. Other memory agent updates are not visible to Cortex-M7 processor software without suitable cache maintenance.</p> <p>Useful for heterogeneous MP-systems where, for example, the Cortex-M7 processor is integrated on the <i>Accelerator Coherency Port (ACP)</i> interface on an MP-capable processor.</p> <p>This bit is RAZ/WI when data cache is not configured.</p>

3.3.9 Auxiliary Bus Fault Status Register

The CM7_ABFSR characteristics are:

Purpose	<p>Stores information on the source of asynchronous bus faults.</p> <p>In the bus-fault handler, software reads the BFSR and if an asynchronous fault is observed, the CM7_ABFSR is read to determine which interfaces are affected. The CM7_ABFSR must be cleared by writing any value to it.</p> <p>For more information about the BFSR, see the <i>ARMv7-M Architecture Reference Manual</i>.</p>
Usage Constraints	<p>Accessible in privileged mode only. It is reset by nSYSRESET and is cleared to 0x0 on writes of any value. The value in this register is only defined when BFSR.IMPRECISERR is 0x1.</p>

Configurations Available in all configurations.

Attributes See the register summary in [Table 3-1 on page 3-3](#).

[Figure 3-9](#) shows the CM7_ABFSR bit assignments.

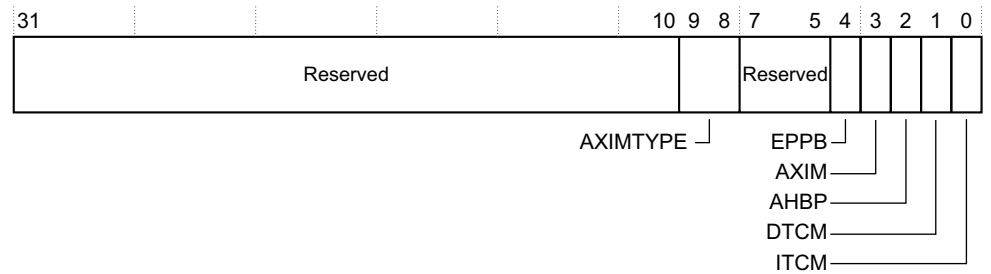

Figure 3-9 CM7_ABFSR bit assignments

[Table 3-12](#) shows the CM7_ABFSR bit assignments.

Table 3-12 CM7_ABFSR bit assignments

Bits	Name	Function
[31:10]	-	Reserved.
[9:8]	AXIMTYPE	Indicates the type of fault on the AXIM interface: 0b00 OKAY. 0b01 EXOKAY. 0b10 SLVERR. 0b11 DECERR. Only valid when AXIM is 1.
[7:5]	-	Reserved.
[4]	EPPB	Asynchronous fault on EPPB interface.
[3]	AXIM	Asynchronous fault on AXIM interface.
[2]	AHBP	Asynchronous fault on AHBP interface.
[1]	DTCM	Asynchronous fault on DTCM interface.
[0]	ITCM	Asynchronous fault on ITCM interface.

3.3.10 Instruction Error bank Register 0-1

The IEBR0-1 characteristics are:

Purpose Stores information about the error detected in the instruction cache during a cache lookup.

Usage Constraints Accessible in privileged mode only.

Configurations Available if the ECC configurable option is implemented.

Attributes See the register summary in [Table 3-1 on page 3-3](#).

[Figure 3-10 on page 3-18](#) shows the IEBR0-1 bit assignments.

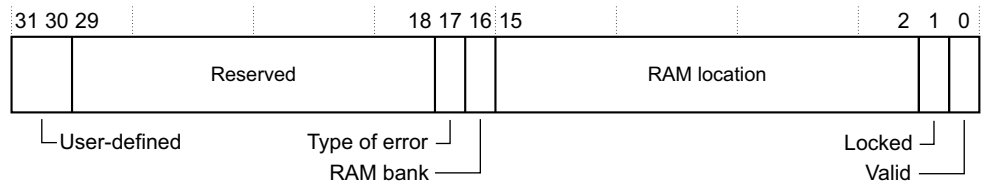

Figure 3-10 IEBR0-1 bit assignments

Table 3-13 shows the IEBR0-1 bit assignments.

Table 3-13 IEBR0-1 bit assignments

Bits	Name	Type	Description
[31:30]	-	RW	User-defined. Error detection logic sets this field to 0b00 on a new allocation and on powerup reset.
[29:18]	-	RW	Reserved
[17]	Type of error	RW	Indicates the error type: 0 Correctable error. 1 Non-correctable error ^a .
[16]	RAM bank	RW	Indicates which RAM bank to use: 0 Tag RAM. 1 Data RAM.
[15:2]	RAM location	RW	Indicates the location in instruction cache RAM: [14] Way. [13:4] Index. [3:2] Line doubleword offset.
[1]	Locked	RW	Indicates whether the location is locked or not locked: 0 Location is not locked and available for hardware to allocate. 1 Location is locked by software. Hardware is not allowed to allocate to this entry. Reset by powerup reset to 0.
[0]	Valid	RW	Indicates whether the entry is valid or not: 0 Entry is invalid. 1 Entry is valid. Reset by powerup reset to 0.

- a. Non-correctable errors are recorded when errors are found in multiple bits of the data read from the RAM. These errors result in data loss or data corruption and therefore are non-recoverable.

3.3.11 Data Error bank Register 0-1

The DEBR0-1 characteristics are:

Purpose	Stores information about the error detected in the data cache during a cache lookup.
Usage Constraints	Accessible in privileged mode only.
Configurations	Available if the ECC configurable option is implemented.
Attributes	See the register summary in Table 3-1 on page 3-3 .

[Figure 3-11 on page 3-19](#) shows the DEBR0-1 bit assignments.

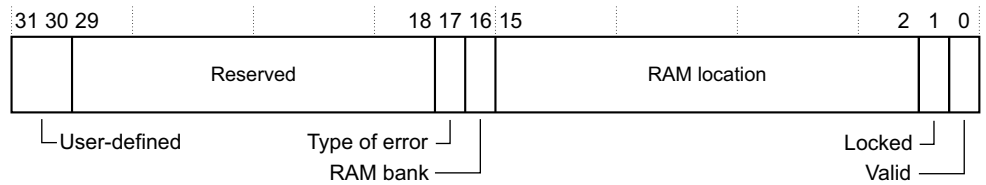

Figure 3-11 DEBR0-1

Table 3-14 shows the DEBR0-1 bit assignments.

Table 3-14 DEBR0-1 bit assignments

Bits	Name	Type	Description
[31:30]	-	RW	User-defined. Error detection logic sets this field to 0b00 on a new allocation and on powerup reset.
[29:18]	-	RW	Reserved.
[17]	Type of error	RW	Indicates the error type: 0 Correctable error. 1 Non-correctable error ^a .
[16]	RAM bank	RW	Indicates which RAM bank to use: 0 Tag RAM. 1 Data RAM.
[15:2]	RAM location	RW	Indicates the data cache RAM location: [15:14] Way. [13:5] Index. [4:2] Line word offset.
[1]	Locked	RW	Indicates whether the location is locked or not locked: 0 Location is not locked and available for hardware to allocate. 1 Location is locked by software. Hardware is not allowed to allocate to this entry. Reset by powerup reset to 0.
[0]	Valid	RW	Indicates whether the entry is valid or not: 0 Entry is invalid. 1 Entry is valid. Reset by powerup reset to 0.

- a. Non-correctable errors are recorded when errors are found in multiple bits of the data read from the RAM. These errors result in data loss or data corruption and therefore are non-recoverable.

3.3.12 AHB Slave Control Register

The CM7_AHBSCR characteristics are:

Purpose Controls the priority between software and AHB slave access to TCMs. See *AHBS interface arbitration* on page 5-31.

Usage Constraints Accessible in privileged mode only.

Configurations Available in all configurations.

Attributes See the register summary in [Table 3-1 on page 3-3](#).

[Figure 3-12](#) shows the CM7_AHBSCR bit assignments.

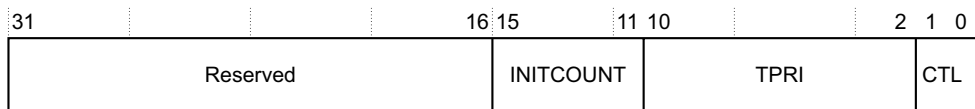

Figure 3-12 CM7_AHBSCR bit assignments

Table 3-15 shows the CM7_AHBSCR bit assignments.

Table 3-15 CM7_AHBSCR bit assignments

Bits	Name	Type	Function
[31:16]	-	-	Reserved.
[15:11]	INITCOUNT	RW	Fairness counter initialization value. Use to demote access priority of the requestor selected by the CM7_AHBSCR.CTL field. The reset value is 0b01.
Note			
<ul style="list-style-type: none"> For round-robin mode set INITCOUNT to 0b01 and CM7_AHBSCR.CTL to 0b00 or 0b01. INITCOUNT must not be set to 0b00 because the demoted requestor then always takes priority when contention occurs, and might cause livelock. INITCOUNT is not used when CM7_AHBSCR.CTL is 0b11. 			
[10:2]	TPRI	RW	<p>Threshold execution priority for AHBS traffic demotion.</p> <p>0b0xxxxxxx Priority is TPRI[7:0]. This is the same as the NVIC register encodings.</p> <p>0b11111111 Priority of -1. This is the priority of the HardFault exception.</p> <p>0b11111110 Priority of -2. This is the priority of the NMI exception.</p>
[1:0]	CTL	RW	<p>AHBS prioritization control:</p> <p>0b00 AHBS access priority demoted. This is the reset value.</p> <p>0b01 Software access priority demoted.</p> <p>0b10 AHBS access priority demoted by initializing the fairness counter to the CM7_AHBSCR.INITCOUNT value when the software execution priority is higher than or equal to the threshold level programmed in CM7_AHBSCR.TPRI. When the software execution priority is below this value, the fairness counter is initialized with 1 (round-robin).</p> <p style="text-align: center;">Note</p> <ul style="list-style-type: none"> The threshold level encoding matches the NVIC encoding and uses arithmetically larger numbers to represent lower priority. The current execution priority of the processor is defined architecturally and includes the effect of the PRIMASK, BASEPRI, and FAULTMASK special-purpose registers. <p>0b11 AHBSPRI signal has control of access priority.</p>

Chapter 4

Initialization

This chapter describes how to initialize the processor and which registers to access to enable functionality before using the processor features. It contains the following section:

- [About Initialization on page 4-2.](#)

4.1 About Initialization

Before you run the application, you might want to:

- Program particular values into various registers, for example, stack pointers.
- Enable various processor features, for example, error correction.
- Program particular values into memory, for example, the *Tightly Coupled Memories* (TCMs).

Other initialization requirements are described in:

- [Initializing the MPU.](#)
- [Initializing the FPU.](#)
- [Initializing and enabling the L1 cache on page 4-3.](#)
- [Disabling cache error checking and correction on page 4-4.](#)
- [Enabling the TCM on page 4-4.](#)
- [Preloading TCM on page 4-5.](#)
- [Enabling the TCM retry and read-modify-write on page 4-5.](#)
- [Enabling the AHBP interface on page 4-6](#)

Some of the requirements for initialization are optional depending on the features implemented in the Cortex-M7 processor.

Note

The Branch predictor is always enabled in the processor, therefore CCR.BP is RAO/WI. See *ARM®v7-M Architecture Reference Manual* for more information on the Configuration and Control register.

4.1.1 Initializing the MPU

If the processor has been implemented with a *Memory Protection Unit* (MPU), before you can use it you must enable the MPU in the MPU_CTRL register. See the *ARM®v7-M Architecture Reference Manual* for more information.

When setting up the MPU, and if the MPU has previously been programmed, disable unused regions to prevent any previous region settings from affecting the new MPU setup.

4.1.2 Initializing the FPU

If the processor has been implemented with a *Floating Point Unit* (FPU) you must enable it before floating point instructions can be executed. The following code is an example of how to enable the feature.

```
CPACR EQU 0xE000ED88

LDR r0, =CPACR

LDR r1, [R0]           ; Read CPACR
ORR r1, R1, #(0xF << 20) ; Set bits 20-23 to enable CP10 and CP11 coprocessors
STR r1, [R0]           ; Write back the modified value to the CPACR

DSB
ISB
```

See the *ARM®v7-M Architecture Reference Manual* for more information.

Note

Floating point logic is only available with the Cortex-M7 processor with FPU.

4.1.3 Initializing and enabling the L1 cache

If the processor has been implemented with L1 data or instruction caches, they must be invalidated before they are enabled in software, otherwise UNPREDICTABLE behavior can occur.

Invalidate the entire data cache

Software can use the following code example to invalidate the entire data cache, if it has been included in the processor. The operation is carried out by iterating over each line of the cache and using the DCISW register in the *Private Peripheral Bus* (PPB) memory region to invalidate the line. The number of cache ways and sets is determined by reading the CCSIDR register.

```

CCSIDR EQU 0xE000ED80      ; Cache size ID register address
CSSELR EQU 0xE000ED84      ; Cache size selection register address
DCISW EQU 0xE000EF60       ; Cache maintenance op address: data cache clean and invalidate by set/way

                                ; CSSELR selects the cache visible in CCSIDR
                                ; 0 = select "level 1 data cache"
MOV r0, #0x0
LDR r11, =CSSELR
STR r0, [r11]
DSB                                ; Ensure write to CSSELR before proceeding

LDR r11, =CCSIDR              ; From CCSIDR
LDR r2, [r11]                 ; Read data cache size information
AND r1, r2, #0x7              ; r1 = cache line size
ADD r7, r1, #0x4              ; r7 = number of words in a cache line

UBFX r4, r2, #3, #10          ; r4 = number of "ways"-1 of data cache
UBFX r2, r2, #13, #15         ; r2 = number of "set"-1 of data cache

CLZ r6, r4                    ; calculate bit offset for "way" in DCISW

LDR r11, =DCISW              ; invalidate cache by set/way

inv_loop1                      ; For each "set"
MOV r1, r4                    ; r1 = number of "ways"-1
LSLS r8, r2, r7               ; shift "set" value to bit 5 of r8

inv_loop2                      ; For each "way"
LSLS r3, r1, r6               ; shift "way" value to bit 30 in r6
ORRS r3, r3, r8               ; merge "way" and "set" value for DCISW
STR r3, [r11]                 ; invalidate D-cache line
SUBS r1, r1, #0x1             ; decrement "way"
BGE inv_loop2                 ; End for each "way"

SUBS r2, r2, #0x1             ; Decrement "set"
BGE inv_loop1                 ; End for each "set"

DSB                                ; Data sync barrier after invalidate cache
ISB                                ; Instruction sync barrier after invalidate cache

```

Invalidate instruction cache

You can use the following code example to invalidate the entire instruction cache, if it has been included in the processor. The operation is carried out by writing to the ICIALLU register in the PPB memory region.

```

ICIALLU EQU 0xE000EF50

        MOV r0, #0x0
        LDR r11, =ICIALLU
        STR r0, [r11]

        DSB
        ISB

```

Enabling data and instruction caches

You can use the following code example to enable the data and instruction cache after they have been initialized. The operation is carried out by modifying the CCR.IC and CCR.DC fields in the PPB memory region.

```

CCR EQU 0xE000ED14

        LDR r11, =CCR
        LDR r0, [r11]
        ORR r0, r0, #0x1:SHL:16 ; Set CCR.DC field
        ORR r0, r0, #0x1:SHL:17 ; Set CCR.IC field
        STR r0, [r11]

        DSB
        ISB

```

4.1.4 Disabling cache error checking and correction

If cache error checking and correction is included in the processor it is enabled by default from reset. The following code example can be used to disable the feature. The operation is carried out by modifying the CM7_CACR.ECCEN bit the PPB memory region.

```

CM7_CACR EQU 0xE000EF9C

        LDR r11, =CM7_CACR
        LDR r0, [r11]
        BFC r0, #0x1, #0x1 ; Clear CM7_CACR.ECCEN
        STR r0, [r11]

        DSB
        ISB

```

Care must be taken when software changes the error checking fields in the CM7_CACR. If the fields are changed when the caches contain data, ECC information in the caches might not be correct for the new setting, resulting in unexpected errors and data loss. Therefore the fields in the CM7_CACR must only be changed when both caches are turned off and the entire cache must be invalidated after the change.

4.1.5 Enabling the TCM

The TCM interfaces can be enabled at reset in the system by an external signal on the processor. If they are disabled at reset then the following code example can be used to enable both the instruction and data TCM interfaces in software:

```

CM7_ITCMCR EQU 0xE000EF90
CM7_DTCMCR EQU 0xE000EF94

```

```

LDR r11, =CM7_ITCMCR
LDR r0, [r11]
ORR r0, r0, #0x1 ; Set CM7_ITCMCR.EN field
STR r0, [r11]

LDR r11, =CM7_DTCMCR
LDR r0, [r11]
ORR r0, r0, #0x1 ; Set CM7_DTCMCR.EN field
STR r0, [r11]

DSB
ISB

```

4.1.6 Preloading TCM

Methods to preload TCMs include:

Memory copy with running boot code

Where boot code includes a memory copy routine that reads data from a ROM, and writes it into the appropriate TCM, you must enable the TCM to do this. This bootcode must be run from an address outside the TCM region.

DMA into TCM

The System includes a DMA device that reads data from a ROM, and writes it to the TCMs through the AHB slave interface. This method can be used to preload the TCM so they can be used by the processor from reset.

Using the TCM from reset

If the TCM interface is configured to enable the TCM at reset and the reset vector address is inside the TCM memory region then the processor boots from TCM. The system must ensure that the bootcode software is present in the appropriate memory region before execution starts. This can be accomplished by either initializing the memory before reset or by transferring the data after reset using the AHB slave interface and asserting the **CPUWAIT** input signal. Asserting this signal stops the processor fetching or executing instructions after reset. When the **CPUWAIT** signal is deasserted the processor starts fetching instructions from the reset vector address in the normal way.

Note

When **CPUWAIT** has been deasserted to start the processor fetching, **CPUWAIT** must not be asserted again except when the processor is under processor reset or Power-on reset; that is **nSYSRESET** or **nPORESET** asserted. The processor does not halt if the **CPUWAIT** is asserted while the processor is running.

4.1.7 Enabling the TCM retry and read-modify-write

If the TCM connected to the processor supports error detection and correction then the TCM interface must be configured to support the retry and read-modify-write features. These can be enabled at reset in the system by external signals on the processor. If they are disabled at reset then the following code example can be used to enable them in software:

```

CM7_ITCMCR EQU 0xE000EF90
CM7_DTCMCR EQU 0xE000EF94

```

```

LDR r11, =CM7_ITCMCR
LDR r0, [r11]
ORR r0, r0, #0x1:SHL:1 ; Set CM7_ITCMCR.RMW field
ORR r0, r0, #0x1:SHL:2 ; Set CM7_ITCMCR.RETEN field
STR r0, [r11]

LDR r11, =CM7_DTCMCR
LDR r0, [r11]
ORR r0, r0, #0x1:SHL:1 ; Set CM7_DTCMCR.RMW field
ORR r0, r0, #0x1:SHL:2 ; Set CM7_DTCMCR.RETEN field
STR r0, [r11]

DSB
ISB

```

4.1.8 Enabling the AHBP interface

The AHBP interface can be enabled at reset in the system by an external signal on the processor. If it is disabled at reset then the following code example can be used to enable the AHBP interface from software:

```

CM7_AHBPCR EQU 0xE000EF98

LDR r11, =CM7_AHBPCR
LDR r0, [r11]
ORR r0, r0, #0x1 ; Set CM7_AHBPCR.EN field
STR r0, [r11]

DSB
ISB

```

Chapter 5

Memory System

This chapter describes the Cortex-M7 processor memory system. It contains the following sections:

- *About the memory system* on page 5-2.
- *Fault handling* on page 5-3.
- *Memory types and memory system behavior* on page 5-5.
- *AXIM interface* on page 5-6.
- *AHB peripheral interface* on page 5-22.
- *AHB slave interface* on page 5-30.
- *TCM interfaces* on page 5-33.
- *L1 caches* on page 5-37.

5.1 About the memory system

This section provides an overview of the Cortex-M7 processor memory system.

The Cortex-M7 processor memory system can be configured during implementation and integration. It consists of:

- Separate optional instruction and data caches.
- Multiple optional *Tightly-Coupled Memory* (TCM) areas.
- An *AHB Slave* (AHBS) interface.
- An optional *Memory Protection Unit* (MPU). See [Chapter 6 Memory Protection Unit](#).
- MBIST interface.

The cache architecture is Harvard, that is, only instructions can be fetched from the instruction cache, and only data can be read from and written to the data cache.

In parallel with each of the caches are two areas of dedicated RAM accessible to both the instruction and data sides. These are regions of TCM.

Instruction TCM (ITCM) uses the ITCM interface and the *Data TCM* (DTCM) uses two interfaces, D0TCM and D1TCM. [Cortex-M7 functional diagram on page 1-6](#) shows this.

The ITCM interface is 64-bits wide. The DTCM is divided into two 32-bit wide interfaces, D0TCM and D1TCM. The upper 32-bits of data is on the D1TCM interface and the lower 32-bits of the data is on the D0TCM interface.

Memory accesses to the ITCM, required for fetching instructions and for data transfer instructions, are performed if the address is in an enabled TCM region. Remaining instruction accesses and remaining data accesses that are not in a peripheral interface region are looked up in the appropriate L1 cache if they are cacheable. Accesses that are not serviced by the memory system are passed through the *AXI master* (AXIM) interface or the AHBP interface to the external memory system connected to the processor.

Both instruction and data cache RAM can be configured at implementation time to have *Error Correcting Code* (ECC) to protect the data stored in the memory from errors. Each TCM interface can support external logic to the processor to report to the processor that an error has occurred.

The processor includes support for direct access to the TCM through the AHBS interface. The interface provides high bandwidth for DMA traffic to the memory and can be used when the remainder of the processor is in low-power standby mode, with the internal clock disabled.

The optional MPU handles both the instruction and data memory accesses. The MPU is responsible for protection checking, address access permissions, and memory attributes for all accesses. Some of these attributes can be passed through the AXIM interface or AHBP interface to the external memory system.

The memory system includes a monitor for exclusive accesses. Exclusive load and store instructions, for example LDREX and STREX, can be used with the appropriate memory monitoring to provide inter-process or inter-processor synchronization and semaphores. See the *ARM[®]v7-M Architecture Reference Manual* for more information.

The processor is designed for use in chip designs that use the AMBA 4 AXI and AMBA 3 AHB-Lite protocols.

5.2 Fault handling

Faults can occur on instruction fetches for the following reasons:

- MPU MemManage.
- External AXI *slave error* (SLVERR).
- External AXI *decode error* (DECERR).
- TCM external error.
- Breakpoints, and vector capture events.

Faults can occur on data accesses for the following reasons:

- MPU MemManage.
- Alignment UsageFault.
- External AXI slave error (SLVERR).
- External AXI decode error (DECERR).
- External AHB error from the AHBP port.
- TCM external error.
- Watchpoints.

Fault handling is described in:

- [Faults](#).
- [Usage models on page 5-4](#).

5.2.1 Faults

The classes of fault that can occur are:

- [MPU faults](#).
- [External faults](#).
- [Debug events on page 5-4](#).
- [Synchronous and asynchronous faults on page 5-4](#).

MPU faults

The MPU can generate a fault for various reasons. MPU faults are always synchronous, and take priority over external faults. If an MPU fault occurs on an access that is not in the TCM, the AXI or AHB transactions for that access are not performed.

External faults

A memory access or instruction fetch performed through the AXIM interface can generate two different types of error response, a *slave error* (SLVERR) or *decode error* (DECERR). These are known as external AXI errors, because they are generated by the AXI system outside the processor.

A memory access performed through the AHBP interface can generate a single error response. The processor manages this in the same way as a response of SLVERR from the AXI interface.

A memory or instruction fetch access performed on the TCM interface can generate a single error response. The processor manages this in the same way as a response of SLVERR from the AXI interface.

Synchronous faults are generated for instruction fetches and data loads. All stores generate asynchronous faults.

Note

An AXI slave device in the system that cannot handle exclusive transactions returns OKAY in response to an exclusive read. This is also treated as an external error, and the processor behaves as if the response was SLVERR.

Debug events

The debug logic in the processor can be configured to generate breakpoints or vector capture events on instruction fetches, and watchpoints on data accesses. If the processor is software-configured for monitor-mode debugging, a fault is taken when one of these events occurs, or when a BKPT instruction is executed. For more information, see [Chapter 9 Debug](#).

Synchronous and asynchronous faults

See [External faults on page 5-3](#) for more information about the differences between synchronous and asynchronous faults.

5.2.2 Usage models

This section describes some methods for handling errors in a system. Exactly how you program the processor to handle faults depends on the configuration of your processor and system, and what you are trying to achieve.

If a fault exception is taken, the fault handler reads the information in the link register, *Program Status Register (PSR)* in the stack, and fault status registers to determine the type of fault. Some types of fault are fatal to the system, and others can be fixed, and program execution resumed. For example, an MPU background MemManage might indicate a stack overflow, and be rectified by allocating more stack and reprogramming the MPU to reflect this. Alternatively, an asynchronous external fault might indicate that a software error meant that a store instruction occurred to an unmapped memory address. Such a fault is fatal to the system or process because no information is recorded about the address the error occurred on, or the instruction that caused the fault.

[Table 5-1](#) shows the types of fault that are typically fatal because either the location of the error is not recorded or the error is unrecoverable. Some faults that are marked as not fatal might turn out to be fatal in some systems when the cause of the error has been determined. For example, an MPU background MemManage fault might indicate a stack overflow, that can be rectified, or it might indicate that, because of a bug, the software has accessed a nonexistent memory location, that can be fatal. These cases can be distinguished by determining the location where the error occurred.

Table 5-1 Types of faults

Type of fault	Conditions	Source	Synchronous	Fatal
MPU	Access not permitted by MPU ^a	MPU	Yes	No
Synchronous external	Load using external memory interface	AXIM, AHBP	Yes	No
Asynchronous external	Store to Normal or Device memory using external memory interface	AXIM, AHBP	No	Yes

a. See the *ARM[®]v7-M Architecture Reference Manual* for more information.

5.3 Memory types and memory system behavior

The behavior of the memory system depends on the type attribute of the memory that is being accessed:

- By default, only Normal, Non-shareable memory regions can be cached in the RAMs. Caching only takes place if the appropriate cache is enabled and the memory type is cacheable. Shared cacheable memory regions can be cached if CACR.SIWT is set to 1.
- The store buffer can merge any stores to Normal memory if they are not from a store exclusive instruction accessing a memory region marked as Shared. See [Store buffer on page 5-38](#) for more information.
- Only non-cached Shared exclusive transactions are marked as exclusive on the external interface. Load and store exclusive instructions to Shared cacheable memory regions do not result in any accesses marked as exclusive on the external interface if CACR.SIWT is set to 1.
- Only Normal memory is considered restartable, that is, a multi-word transfer can be abandoned part way through because of an interrupt, to be restarted after the interrupt has been handled. See [Exception handling on page 2-9](#) for more information about interrupt behavior.
- For exclusive accesses to Non-shared memory only the internal exclusive monitor is updated and checked. Exclusive accesses to Shared memory are checked using the internal monitor and also, if necessary, using an external monitor using the external memory interface AXIM or AHBP.

[Table 5-2](#) summarizes the processor memory types and associated behavior.

Table 5-2 Memory types and associated behavior

Memory type		Can be cached	Merging	Restartable	Exclusives handled
Normal	Shared	No ^a	Yes	Yes	Internal and external
	Non-shared	Yes	Yes	Yes	Internal only
Device	Shared	No	No	No	Internal and external
	Non-shared	No	No	No	Internal only
Strongly-ordered	Shared	No	No	No	Internal and external

a. Unless CACR.SIWT is set to 1.

5.4 AXIM interface

This section describes the AXIM interface. The AXIM interface is a single 64-bit wide interface that connects to an external memory system. It is used for:

- Instruction fetches.
- Data cache linefills and evictions.
- Non-cacheable Normal-type memory data accesses.
- Device and Strongly-ordered type data accesses, normally to peripherals.

The AXIM interface conforms to the AXI4 standard as described in the *ARM® AMBA® AXI and ACE Protocol Specification*. Within the AXI standard, the AXIM interface uses a number of extension signals to indicate inner memory attributes and the request source. See [AXI extensions on page 5-10](#).

The AXIM interface can run at the same frequency as the processor or at a lower synchronous frequency.

———— **Note** —————

References in this section to an *AXI slave* refer to the AXI slave in the external system that is connected to the processor AXIM interface.

The following sections describe the attributes of the AXIM interface, and provide information about the types of burst generated:

- [AXI attributes and transactions](#).
- [Identifiers for AXIM interface accesses on page 5-9](#).
- [AXI extensions on page 5-10](#).
- [Memory system implications for AXI accesses on page 5-10](#).

5.4.1 AXI attributes and transactions

[Table 5-3](#) shows the AXI attributes and transactions for the AXIM interface when the processor is configured with the L1 data cache. This is for use in a native AXI system with high memory bandwidth and supports multiple outstanding transactions, also known as a high performance AXIM interface.

Table 5-3 High performance AXIM attributes and transactions

Attribute	Value	Description
Write issuing capability	39	Consisting of: <ul style="list-style-type: none"> • 15 writes to Strongly-ordered or Device memory. • 24 writes to Normal memory, that can be evictions, write bursts or single writes. A maximum of 17 of these can be to cacheable memory and a maximum of 10 to Non-cacheable or shareable memory.
Read issuing capability	7	Consisting of: <ul style="list-style-type: none"> • 2 data linefills. • 4 Non-cacheable data reads. • 1 instruction fetch or instruction linefill.

Table 5-3 High performance AXIM attributes and transactions (continued)

Attribute	Value	Description
Write ID capability	4	Consisting of: <ul style="list-style-type: none"> • 1 reserved for Strongly-ordered or Device memory. • 1 reserved for Normal, cacheable and Non-shareable memory. • 1 reserved for Normal, Non-cacheable or Shareable memory. • 1 reserved for cache line evictions (Normal, cacheable, Write-Back memory).
Read ID capability	4	-
Combined issuing capability	40	Consisting of: <ul style="list-style-type: none"> • 39 outstanding writes. • 1 instruction fetch^a.

a. The maximum issuing capability of the memory system is limited to one outstanding instruction read because all data reads are hazarded in the BIU when the maximum number of write transactions have been issued.

Only a subset of all possible AXI transactions can be generated. These are:

- For Normal, cacheable memory:
 - WRAP4 64-bit reads, for load and Write-Back Write-Allocate store linefills and instruction linefills.
 - INCR4 64-bit writes, for evictions.
 - INCR N (N:1-4) 64-bit for write transfers, for coalesced individual Write-Through or Write-Back, no Write-Allocate stores.
 - INCR N (N:1-4) 64-bit for read transfers, for loads when the data cache is disabled, or for instruction fetches when the instruction cache is disabled.
- For Normal, Non-cacheable memory:
 - INCR N (N:1-4) 64-bit for read transfers, for individual loads and load multiples.
 - INCR N (N:1-4) 64-bit for write transfers, for coalesced individual stores and store multiples.
 - INCR N (N:1-4) 64-bit for read transfers, for instruction fetches.
 - INCR 1 8-bit, 16-bit, and 32-bit exclusive reads and writes, for shared exclusives.
- For Strongly-ordered or Device memory:
 - INCR 1 8-bit, 16-bit and 32-bit reads and writes, for individual load and stores.
 - INCR 1 32-bit for read transfers, load multiples.
 - INCR N (N:1-2) 32-bit for write transfers, for store multiples.
 - INCR 1 8-bit, 16-bit and 32-bit exclusive reads and writes, for shared exclusives.
- No FIXED bursts are used.
- Write bursts to Normal memory can use the following optimizations:
 - Entire beats with no strobes set.
 - Non-contiguous strobes per beat.

These are allowed on AXI but have implications for bridging to AHB.

For more information on IDs used for different transactions, see [Identifiers for AXIM interface accesses on page 5-9](#).

Table 5-4 shows the AXI attributes and transactions for when the processor is not configured to include the L1 data cache. That is, if you want to use it in a low-cost AXI system, or bridged to AHB, that has a low-bandwidth memory system, like on an off-chip memory system.

Table 5-4 Area optimized AXIM attributes and transactions

Attribute	Value	Description
Write issuing capability	25	Consisting of: <ul style="list-style-type: none"> • 15 writes to Strongly-ordered or Device memory. • 10 writes to Normal memory.
Read issuing capability	5	Consisting of: <ul style="list-style-type: none"> • 4 data read. • 1 instruction fetch or instruction linefill.
Write ID capability	2	Consisting of: <ul style="list-style-type: none"> • 1 reserved for Strongly-ordered or Device memory. • 1 reserved for Normal memory.
Read ID capability	2	-
Combined issuing capability	26	Consisting of: <ul style="list-style-type: none"> • 25 outstanding writes. • 1 instruction fetch^a.

a. The maximum issuing capability of the memory system is limited to one outstanding instruction read because all data reads are hazarded in the BIU when the maximum number of write transactions have been issued.

Only a subset of all possible AXI transactions is generated. These are:

- For Normal memory:
 - WRAP4 64-bit read transfers, for instruction linefills where instruction cache is included.
 - INCR N (N:1-4) 64-bit for read transfers, for individual loads and load multiples.
 - INCR N (N:1-4) 64-bit for write transfers, for coalesced individual stores and store multiples.
 - INCR N (N:1-4) 64-bit for read transfers, for Non-cacheable instruction fetches or all instruction fetches with no instruction cache.
 - INCR 1 8-bit, 16-bit and 32-bit exclusive reads and writes, for shared exclusives.
- For Strongly-ordered or Device memory:
 - INCR N (N:1-2) 32-bit for read transfers, for individual loads and load multiples.
 - INCR N (N:1-2) 32-bit for write transfers, for individual stores and store multiples.
 - INCR 1 8-bit, 16-bit and 32-bit exclusive reads and writes, for shared exclusives.
- No FIXED bursts are used.
- Write bursts to Normal memory can use the following optimizations:
 - Entire beats with no strobes set.
 - Non-contiguous strobes per beat.

These are allowed on AXIM interface but have implications for bridging to AHB.

For more information on IDs used for different transactions, see *Identifiers for AXIM interface accesses* on page 5-9.

5.4.2 Identifiers for AXIM interface accesses

The following ID values are for read and write channels, and Write-Allocate memory accesses on the AXIM interface:

- Read channels, **ARID[2:0]**, **RID[2:0]**:
 - 0b000 Normal Non-cacheable, Device, and Strongly-ordered reads.
 - 0b011, 0b010 Data cache line-fills.
 - 0b100 Instruction fetches.
- Write channels, **AWID[1:0]**, **WID[1:0]**, **BID[1:0]**:
 - 0b00 Normal, Non-cacheable writes, All shared exclusive writes, for example from STREX.
 - 0b01 Normal cacheable writes to Write-Through and Write-Back, Non Write-Allocate memory.
 - 0b10 Device and Strongly-ordered writes.
 - 0b11 Evictions to Normal cacheable Write-Back memory.

WID is not a required signal for AMBA 4 AXI. It is included for compatibility with AMBA 3 AXI systems.

5.4.3 AXI privilege information

AXI provides information about the privilege level of an access on the **ARPROT** and **AWPROT** signals. However, when accesses might be cached or merged together, the resulting transaction can have both privileged and user data combined. If this happens, the Cortex-M7 processor marks the transaction as privileged, even if it was initiated by a user process.

Table 5-5 shows Cortex-M7 mode and APROT values.

Table 5-5 Cortex-M7 mode and APROT values

Processor mode	Type of access	Value of APROT
-	Cacheable read access	Always marked as Privileged
User	Non-cacheable read access	User except for LDM, LDRD and POP when the L1 data cache is implemented
Privileged		Privileged
User	Device or Strongly-ordered read access	User
Privileged		Privileged
-	Cacheable write access	Always marked as Privileged
User	Device or Strongly-ordered write access	User
Privileged		Privileged
User	Normal non-cacheable write access	Privileged, except for STREXB, STREXH, and STREX
Privileged		Privileged

5.4.4 Write response

The AXIM interface requires that the slave does not return a write response until it has received the write address.

Note

This write response requirement is mandatory for systems using the AMBA 4 AXI protocol. It is also required if the Cortex-M7 processor is used with an external memory system using the AMBA 3 AXI protocol.

5.4.5 AXI extensions

The AXIM interface uses the **ARCACHE** and **AWCACHE** AXI signals and the **ARSHARE**, **AWSHARE**, **ARINNER**, and **AWINNER** extension signals to indicate the memory attributes of the transfer, as returned by the MPU:

- **ARCACHE** and **AWCACHE** of the master interface are generated from the memory type and outer region attributes.
- **ARINNER** and **AWINNER** are generated from the memory type and inner region attributes.
- **ARSHARE** and **AWSHARE** are asserted for transactions to shared memory regions.

In addition to these attribute extension signals the AXIM interface includes the following signals:

AWMASTER and ARMASTER

Indicates the source of the memory request. When set to:

- 0** The request has been generated by software running on the processor.
- 1** The request has been generated by a debug request on the *AHB Debug* (AHBD) interface.

AWSPARSE The **AWSPARSE** is part of the write address channel signal group and indicates the burst uses sparse byte write-strobes, that is some of the beats of the write burst do not contain data. You can use this signal to optimize systems that bridge the AMBA 4 AXI protocol to AHB protocol.

See the *ARM® AMBA® AXI and ACE Protocol Specification* for valid encodings for all the **AxCACHE** and **AxINNER** signals.

5.4.6 Memory system implications for AXI accesses

The attributes of the memory being accessed can affect an AXI access. The memory system can cache any Normal memory address that is marked as either:

- Cacheable, Write-Back, Read-Allocate, Write-Allocate, Non-shareable.
- Cacheable, Write-Back, Read-Allocate only, Non-shareable.
- Cacheable, Write-Through, Read-Allocate only, Non-shareable.

However, Device and Strongly-ordered memory is always Non-cacheable. Also, any unaligned access to Device or Strongly-ordered memory generates alignment UsageFault and therefore does not cause any AXI transfer. This means that the access examples given in this chapter never show unaligned accesses to Device or Strongly-ordered memory.

Note

Memory regions marked as Non-Cacheable Normal must not be used to access read-sensitive peripherals in a system. This is because read transactions to these regions from the processor can be repeated multiple times if the originating load instruction is interrupted.

5.4.7 AXIM interface transfers

The processor conforms to the *ARM® AMBA® AXI and ACE Protocol Specification*, but it does not generate all the AXI transaction types that the specification permits. This section describes the types of AXI transaction that the AXIM interface does not generate.

If you are designing an AXI slave to work only with the Cortex-M7 processor, and there are no other AXI masters in your system, you can take advantage of these restrictions and the interface attributes, described in [Table 5-3 on page 5-6](#), to simplify the slave.

This section also contains tables that show some examples of the types of AXI burst that the processor generates. However, because a particular type of transaction is not shown here does not mean that the processor does not generate such a transaction.

Note

An AXI slave device connected to the AXIM interface must be capable of handling every kind of transaction permitted by the *ARM® AMBA® AXI and ACE Protocol Specification*, except where there is an explicit statement in this chapter that such a transaction is not generated. You must not infer any additional restrictions from the example tables given.

Load and store instructions to Non-cacheable memory might not result in an AXI transfer because the data might either be retrieved from, or merged into the internal store data buffers. The exceptions to this are loads or stores to Strongly-ordered or Device memory. These always result in AXI transfers. See [Strongly-ordered and Device transactions on page 5-12](#).

[Restrictions on AXI transfers on page 5-12](#) describes restrictions on the type of transfers that the AXIM interface generates. If the processor is powered up, the buffered write response and read data channel ready signals, **BREADY** and **RREADY**, are always asserted. They are deasserted when the processor enters Dormant or Shutdown mode. You must not make any other assumptions about the AXI handshaking signals, except that they conform to the *ARM® AMBA® AXI and ACE Protocol Specification*.

The following sections give examples of transfers generated by the AXIM interface:

- [Restrictions on AXI transfers on page 5-12](#).
- [Strongly-ordered and Device transactions on page 5-12](#).
- [Linefills on page 5-17](#).
- [Cache line write-back \(eviction\) on page 5-17](#).
- [Non-cacheable reads on page 5-17](#).
- [Non-cacheable, Write-Back no Write-Allocate or Write-Through writes on page 5-17](#).
- [AXI transaction splitting on page 5-18](#).
- [Normal write merging on page 5-19](#).

Restrictions on AXI transfers

The AXIM interface applies the following restrictions to the AXI transactions it generates:

- A burst never transfers more than 32 bytes.
- The burst length is never more than four transfers.
- The maximum length of a Strongly-ordered or Device write burst is two transfers. Strongly-ordered or Device reads are always one transfer.
- No transaction ever crosses a 32-byte boundary in memory. See [AXI transaction splitting on page 5-18](#).
- FIXED bursts are never used.
- The write address channel always issues INCR type bursts, and never WRAP or FIXED.
- WRAP type read bursts, see [Linefills on page 5-17](#):
 - Are used only for linefills (reads) of cacheable Normal memory.
 - Always have a size of 64 bits, and a length of four transfers.
 - Always have a start address that is 64-bit aligned.
- If the transfer size is 8 bits or 16 bits then the burst length is always one transfer.
- The transfer size is never greater than 64 bits, because it is a 64-bit AXI bus.
- Instruction fetches, identified by **ARPROT[2]**, are always a 64 bit transfer size, and never locked or exclusive.
- Transactions to Device and Strongly-ordered memory are always to addresses that are aligned for the transfer size. See [Strongly-ordered and Device transactions](#).
- Exclusive accesses are always to addresses that are aligned for the transfer size.
- Only exclusive accesses to shared memory result in exclusive accesses on the AXIM, identified by **ARLOCK** and **AWLOCK**. Exclusive accesses to non-shared memory are marked as non-exclusive accesses on the bus.

Strongly-ordered and Device transactions

A load or store instruction to or from Strongly-ordered or Device memory always generates AXI transactions of the same size as implied by the instruction. All accesses using LDM, STM, LDRD, or STRD instructions to Strongly-ordered or Device memory occur as 32-bit transfers.

LDRB

[Table 5-6](#) shows the values of **ARADDR**, **ARBURST**, **ARSIZE**, and **ARLEN** for a LDRB from bytes 0-7 in Strongly-ordered or Device memory.

Table 5-6 LDRB from Strongly-ordered or Device

Address[2:0]	ARADDR	ARBURST	ARSIZE	ARLEN
0x0 (byte 0)	0x00	Incr	8-bit	1 data transfer
0x1 (byte 1)	0x01	Incr	8-bit	1 data transfer
0x2 (byte 2)	0x02	Incr	8-bit	1 data transfer
0x3 (byte 3)	0x03	Incr	8-bit	1 data transfer

Table 5-6 LDRB from Strongly-ordered or Device (continued)

Address[2:0]	ARADDR	ARBURST	ARSIZE	ARLEN
0x4 (byte 4)	0x04	Incr	8-bit	1 data transfer
0x5 (byte 5)	0x05	Incr	8-bit	1 data transfer
0x6 (byte 6)	0x06	Incr	8-bit	1 data transfer
0x7 (byte 7)	0x07	Incr	8-bit	1 data transfer

LDRH

Table 5-7 shows the values of **ARADDR**, **ARBURST**, **ARSIZE**, and **ARLEN** for a LDRH from halfwords 0-3 in Strongly-ordered or Device memory.

Table 5-7 LDRH from Strongly-ordered or Device memory

Address[2:0]	ARADDR	ARBURST	ARSIZE	ARLEN
0x0 (halfword 0)	0x00	Incr	16-bit	1 data transfer
0x2 (halfword 1)	0x02	Incr	16-bit	1 data transfer
0x4 (halfword 2)	0x04	Incr	16-bit	1 data transfer
0x6 (halfword 3)	0x06	Incr	16-bit	1 data transfer

Note

A load of a halfword from Strongly-ordered or Device memory addresses 0x1, 0x3, 0x5, or 0x7 generates an alignment UsageFault.

LDR or LDM that transfers one register

Table 5-8 shows the values of **ARADDR**, **ARBURST**, **ARSIZE**, and **ARLEN** for a LDR or an LDM that transfers one register (an LDM1) in Strongly-ordered or Device memory.

Table 5-8 LDR or LDM1 from Strongly-ordered or Device memory

Address[2:0]	ARADDR	ARBURST	ARSIZE	ARLEN
0x0 (word 0)	0x00	Incr	32-bit	1 data transfer
0x4 (word 1)	0x04	Incr	32-bit	1 data transfer

Note

A load of a word from Strongly-ordered or Device memory addresses 0x1, 0x2, 0x3, 0x5, 0x6, or 0x7 generates an alignment UsageFault.

LDM that transfers two registers

Table 5-9 shows the values of **ARADDR**, **ARBURST**, **ARSIZE**, and **ARLEN** for a LDM that transfers two registers (an LDM2) in Strongly-ordered or Device memory.

Table 5-9 LDM2, Strongly-ordered or Device memory

Address[3:0]	ARADDR	ARBURST	ARSIZE	ARLEN
0x0 (word 0)	0x00	Incr	32-bit	1 data transfer
	0x04	Incr	32-bit	1 data transfer
0x4 (word 1)	0x04	Incr	32-bit	1 data transfer
	0x08	Incr	32-bit	1 data transfer
0x8 (word 2)	0x08	Incr	32-bit	1 data transfer
	0x0C	Incr	32-bit	1 data transfer
0xC (word 3)	0x0C	Incr	32-bit	1 data transfer
	0x10	Incr	32-bit	1 data transfer

Note

A load-multiple from address 0x1, 0x2, 0x3, 0x5, 0x6, 0x7, 0x9, 0xA, 0xB, 0xD, 0xE, or 0xF generates an alignment UsageFault.

STRB

Table 5-10 shows the values of **AWADDR**, **AWBURST**, **AWSIZE**, **AWLEN**, and **WSTRB** for an STRB to Strongly-ordered or Device memory over the AXIM interface.

Table 5-10 STRB to Strongly-ordered or Device memory

Address[2:0]	AWADDR	AWBURST	AWSIZE	AWLEN	WSTRB
0x0 (byte 0)	0x00	Incr	8-bit	1 data transfer	0b00000001
0x1 (byte 1)	0x01	Incr	8-bit	1 data transfer	0b00000010
0x2 (byte 2)	0x02	Incr	8-bit	1 data transfer	0b00000100
0x3 (byte 3)	0x03	Incr	8-bit	1 data transfer	0b00001000
0x4 (byte 4)	0x04	Incr	8-bit	1 data transfer	0b00010000
0x5 (byte 5)	0x05	Incr	8-bit	1 data transfer	0b00100000
0x6 (byte 6)	0x06	Incr	8-bit	1 data transfer	0b01000000
0x7 (byte 7)	0x07	Incr	8-bit	1 data transfer	0b10000000

STRH

Table 5-11 shows the values of **AWADDR**, **AWBURST**, **AWSIZE**, **AWLEN**, and **WSTRB** for an STRH over the AXIM interface to Strongly-ordered or Device memory.

Table 5-11 STRH to Strongly-ordered or Device memory

Address[2:0]	AWADDR	AWBURST	AWSIZE	AWLEN	WSTRB
0x0 (halfword 0)	0x00	Incr	16-bit	1 data transfer	0b00000011
0x2 (halfword 1)	0x02	Incr	16-bit	1 data transfer	0b00001100
0x4 (halfword 2)	0x04	Incr	16-bit	1 data transfer	0b00110000
0x6 (halfword 3)	0x06	Incr	16-bit	1 data transfer	0b11000000

Note

A store of a halfword to Strongly-ordered or Device memory addresses 0x1, 0x3, 0x5, or 0x7 generates an alignment UsageFault.

STR or STM of one register

Table 5-12 shows the values of **AWADDR**, **AWBURST**, **AWSIZE**, **AWLEN**, and **WSTRB** for an STR or an STM that transfers one register (an STM1) over the AXIM interface to Strongly-ordered or Device memory.

Table 5-12 STR or STM1 to Strongly-ordered or Device memory

Address[2:0]	AWADDR	AWBURST	AWSIZE	AWLEN	WSTRB
0x0 (word 0)	0x00	Incr	32-bit	1 data transfer	0b00001111
0x4 (word 1)	0x04	Incr	32-bit	1 data transfer	0b11110000

Note

A store of a word to Strongly-ordered or Device memory addresses 0x1, 0x2, 0x3, 0x5, 0x6, or 0x7 generates an alignment UsageFault.

STM of five registers

Table 5-13 shows the values of **AWADDR**, **AWBURST**, **AWSIZE**, **AWLEN**, and first **WSTRB** for an STM that writes five registers (an STM5) over the AXIM interface to Strongly-ordered or Device memory.

Table 5-13 STM5 to Strongly-ordered or Device memory to word 0 or 1

Address[4:0]	AWADDR	AWBURST	AWSIZE	AWLEN	First WSTRB
0x00 (word 0)	0x00	Incr	32-bit	2 data transfer	0b00001111
	0x08	Incr	32-bit	2 data transfers	0b00001111
	0x10	Incr	32-bit	1 data transfer	0b00001111

Table 5-13 STM5 to Strongly-ordered or Device memory to word 0 or 1 (continued)

Address[4:0]	AWADDR	AWBURST	AWSIZE	AWLEN	First WSTRB
0x04 (word 1)	0x04	Incr	32-bit	1 data transfer	0b11110000
	0x08	Incr	32-bit	2 data transfers	0b00001111
	0x10	Incr	32-bit	2 data transfers	0b00001111

Note

A store-multiple to address 0x1, 0x2, 0x3, 0x5, 0x6, or 0x7 generates an alignment UsageFault.

Linefills

Loads and instruction fetches from Normal, cacheable memory that do not hit in the cache generate a cache linefill when the appropriate cache is enabled. Table 5-14 shows the values of **ARADDR**, **ARBURST**, **ARSIZE**, and **ARLEN** for cache linefills.

Table 5-14 Linefill behavior on the AXI interface

Address[4:0] ^a	ARADDR	ARBURST	ARSIZE	ARLEN
0x00-0x07	0x00	Wrap	64-bit	4 data transfers
0x08-0x0F	0x08	Wrap	64-bit	4 data transfers
0x10-0x17	0x10	Wrap	64-bit	4 data transfers
0x18-0x1F	0x18	Wrap	64-bit	4 data transfers

a. These are the bottom five bits of the address of the access that cause the linefill, that is, the address of the critical word.

Cache line write-back (eviction)

When a valid and dirty cache line is evicted from the data cache, a write-back of the data must occur. Table 5-15 shows the values of **AWADDR**, **AWBURST**, **AWSIZE**, and **AWLEN** for cache line write-backs, over the AXIM interface.

Table 5-15 Cache line write-back

AWADDR[4:0]	AWBURST	AWSIZE	AWLEN
0x00	Incr	64-bit	4 data transfers

Non-cacheable reads

Load instructions accessing Non-cacheable Normal memory generate AXI bursts that are not necessarily the same size or length as the instruction implies. In addition, if the data to be read is contained in the store buffer, the instruction might not generate an AXI read transaction at all.

Non-cacheable, Write-Back no Write-Allocate or Write-Through writes

Store instructions to Non-cacheable, Write-Back no Write-Allocate Cacheable and Write-Through Cacheable memory generate AXI bursts that are not necessarily the same size or length as the instruction implies. The AXIM interface asserts byte-lane-strobes, **WSTRB[7:0]**, to ensure that only the bytes that were written by the instruction are updated.

The tables in this section give examples of the types of AXI transaction that might result from various store instructions, accessing various addresses in Normal memory. They are provided as examples only, and are not an exhaustive description of the AXI transactions. Depending on the state of the processor, and the timing of the accesses, the actual bursts generated might have a different size and length to the examples shown, even for the same instruction.

In addition, write operations to Normal memory can be merged to create more complex AXI transactions. See *Normal write merging on page 5-19* for examples.

Table 5-16 shows possible values of **AWADDR**, **AWBURST**, **AWSIZE**, **AWLEN**, and **WSTRB** for an STRH to Normal memory.

Table 5-16 STRH to Cacheable write-through or Non-cacheable Normal memory

Address[2:0]	AWADDR	AWBURST	AWSIZE	AWLEN	WSTRB
0x0 (byte 0)	0x00	Incr	64-bit	1 data transfer	0b00000011
0x1 (byte 1)	0x00	Incr	64-bit	1 data transfer	0b00000110
0x2 (byte 2)	0x00	Incr	64-bit	1 data transfer	0b00001100
0x3 (byte 3)	0x00	Incr	64-bit	1 data transfer	0b00011000
0x4 (byte 4)	0x00	Incr	64-bit	1 data transfer	0b00110000
0x5 (byte 5)	0x00	Incr	64-bit	1 data transfer	0b01100000
0x6 (byte 6)	0x00	Incr	64-bit	1 data transfer	0b11000000
0x7 (byte 7)	0x00	Incr	64-bit	1 data transfer	0b10000000
	0x08	Incr	64-bit	1 data transfer	0b00000001

Table 5-17 shows possible values of **AWADDR**, **AWBURST**, **AWSIZE**, **AWLEN**, and **WSTRB** for an STR that transfers one register to Normal memory through the AXIM interface.

Table 5-17 STR to Cacheable write-through or Non-cacheable Normal memory

Address[2:0]	AWADDR	AWBURST	AWSIZE	AWLEN	WSTRB
0x0 (byte 0) (word 0)	0x00	Incr	64-bit	1 data transfer	0b00001111
0x1 (byte 1)	0x00	Incr	64-bit	1 data transfer	0b00011110
0x2 (byte 2)	0x00	Incr	64-bit	1 data transfer	0b00111100
0x3 (byte 3)	0x00	Incr	64-bit	1 data transfer	0b01111000
0x4 (byte 4) (word 1)	0x00	Incr	64-bit	1 data transfer	0b11110000
0x5 (byte 5)	0x00	Incr	64-bit	1 data transfer	0b11100000
	0x08	Incr	64-bit	1 data transfer	0b00000001
0x6 (byte 6)	0x00	Incr	64-bit	1 data transfer	0b11000000
	0x08	Incr	64-bit	1 data transfer	0b00000011
0x7 (byte 5)	0x00	Incr	64-bit	1 data transfer	0b10000000
	0x08	Incr	64-bit	1 data transfer	0b00000111

AXI transaction splitting

The processor splits AXI bursts when it accesses addresses across a cache line boundary, that is, a 32-byte boundary. An instruction that accesses memory across one or two 32-byte boundaries generates two or three AXI bursts respectively. The following examples show this behavior. They are provided as examples only, and are not an exhaustive description of the AXI transactions. Depending on the state of the processor, and the timing of the accesses, the actual bursts generated might have a different size and length to the examples shown, even for the same instruction.

For example, LDMIA R10, {R0-R5} loads six words from Non-cacheable, Normal memory. The number of AXI transactions generated by this instruction depends on the base address, R10:

- If all six words are in the same cache line, there is a single AXI transaction. For example, for LDMIA R10, {R0-R5} with R10 = 0x1008, the interface might generate a burst of three, 64-bit read transfers, as shown in [Table 5-18](#).

Table 5-18 AXI transaction splitting, all six words in same cache line

ARADDR	ARBURST	ARSIZE	ARLEN
0x1008	Incr	64-bit	3 data transfers

- If the data comes from two cache lines, then there are two AXI transactions. For example, for LDMIA R10, {R0-R5} with R10 = 0x1010, the interface might generate one burst of two 64-bit reads, and one burst of a single 64-bit read, as shown in [Table 5-19](#).

Table 5-19 AXI transaction splitting, data in two cache lines

ARADDR	ARBURST	ARSIZE	ARLEN
0x1010	Incr	64-bit	2 data transfers
0x1020	Incr	64-bit	1 data transfer

[Table 5-20](#) shows possible values of **ARADDR**, **ARBURST**, **ARSIZE**, and **ARLEN** for an LDR to Non-cacheable Normal memory that crosses a cache line boundary.

Table 5-20 Non-cacheable LDR or LDM1 crossing a cache line boundary

Address[4:0]	ARADDR	ARBURST	ARSIZE	ARLEN
0x1D (byte 29)	0x1D	Incr	32-bit	1 data transfer
	0x20	Incr	32-bit	1 data transfer
0x1E (byte 30)	0x1E	Incr	32-bit	1 data transfer
	0x20	Incr	32-bit	1 data transfer
0x1F (byte 31)	0x1F	Incr	32-bit	1 data transfer
	0x20	Incr	32-bit	1 data transfer

[Table 5-21](#) shows possible values of **AWADDR**, **AWBURST**, **AWSIZE**, **AWLEN**, and **WSTRB** for an STRH to Non-cacheable Normal memory that crosses a cache line boundary.

Table 5-21 Non-cacheable STRH crossing a cache line boundary

Address[4:0]	AWADDR	AWBURST	AWSIZE	AWLEN	WSTRB
0x1F (byte 31)	0x18	Incr	64-bit	1 data transfer	0b10000000
	0x20	Incr	64-bit	1 data transfer	0b00000001

Normal write merging

A store instruction to Non-cacheable, Write-Back no Write-Allocate Cacheable, or Write-Through Cacheable Normal memory might not result in an AXI transfer because of the merging of store data in the internal buffers.

The store buffer can detect when it contains more than one write request to the same cache line for Write-Through Cacheable or Non-cacheable Normal memory. This means it can combine the data from more than one instruction into a single write burst to improve the efficiency of the AXI interface. If the AXIM receives several write requests that do not form a single contiguous burst it can choose to output a single burst, with the **WSTRB** signal low for the bytes that do not have any data.

For write accesses to Normal memory, the store can perform writes out of order, if there are no address dependencies. It can do this to best use its ability to merge accesses.

The instruction sequence in [Example 5-1](#) shows the merging of writes.

Example 5-1 Write merging

```
MOV r0, #0x4000
STRH r1, [r0, #0x18]; Store a halfword at 0x4018
STR r2, [r0, #0xC] ; Store a word at 0x400C
STMIA r0, {r4-r7} ; Store four words at 0x4000
STRB r3, [r0, #0x1D]; Store a byte at 0x401D
```

[Table 5-22](#) shows the values of **AWADDR**, **AWBURST**, **AWSIZE**, **AWLEN**, and **WSTRB** generated if the memory at address 0x4000 is marked as Strongly-ordered or Device type memory.

Table 5-22 AXI transactions for Strongly-ordered or Device type memory

AWADDR	AWBURST	AWSIZE	AWLEN	WSTRB
0x4018	Incr	16-bit	1 data transfer	0b0000011
0x400C	Incr	32-bit	1 data transfer	0b11110000
0x4000	Incr	32-bit	2 data transfers	0b00001111 0b11110000
0x4008	Incr	32-bit	2 data transfers	0b00001111 0b11110000
0x401D	Incr	8-bit	1 data transfer	0b00100000

In [Example 5-1](#), each store instruction produces an AXI burst of the same size as the data written by the instruction.

[Table 5-23](#) shows a possible resulting transaction if the same memory is marked as Non-cacheable Normal, or Write-Through Cacheable.

Table 5-23 AXI transactions for Non-cacheable Normal or Write-Through Cacheable memory

AWADDR	AWBURST	AWSIZE	AWLEN	WSTRB
0x4000	Incr	64-bit	4 data transfers	0b11111111 0b11111111 0b00000000 0b00100011

In this example:

- The store buffer has merged the STRB and STRH writes into one buffer entry, and therefore a single AXI transfer, the fourth in the burst.
- The writes, that occupy three buffer entries, have been merged into a single AXI burst of four transfers.
- The write generated by the STR instruction has not occurred, because it was overwritten by the STM instruction.
- The write transfers have occurred out of order with respect to the original program order.

The transactions shown in [Table 5-23 on page 5-20](#) show this behavior. They are provided as examples only, and are not an exhaustive description of the AXI transactions. Depending on the state of the processor, and the timing of the accesses, the actual bursts generated might have a different size and length to the examples shown, even for the same instruction.

If the same memory is marked as Write-Back Cacheable, and the addresses are allocated into a cache line, no AXI write transactions occur until the cache line is evicted and performs a write-back transaction. See [Cache line write-back \(eviction\) on page 5-17](#).

5.5 AHB peripheral interface

This section describes the attributes of the *AHB-Lite Peripheral* (AHBP) interface, and provides information about the types of burst generated.

The AHBP interface is a single 32-bit wide interface that connects to an external memory system. It is used only for data access. Instruction fetches are never performed on the interface.

5.5.1 AHBP interface transfers

The AHBP interface conforms to the AHB-Lite specification, but it does not generate all the AHB transaction types that the specification permits. This section describes the types of AHB transaction that the AHBP interface does not generate. If you are designing an AHB slave to work only with the Cortex-M7 processor AHBP interface, you can take advantage of these restrictions and the interface attributes described in the following sections to simplify the slave.

This section also contains tables that show some of the types of AHB transaction that the processor generates. However, because a particular type of transaction is not shown here does not mean that the processor does not generate such a transaction.

———— **Note** ————

An AHB slave device connected to the AHBP interface must be capable of handling every kind of transaction permitted by the AHB specification, except where there is an explicit statement in this chapter that such a transaction is not generated. You must not infer any additional restrictions from the example tables given.

Restrictions on AHBP interface transfers describes restrictions on the type of transfers that the AHBP interface generates.

The following sections give examples of transfers generated by the AHBP interface:

- *Restrictions on AHBP interface transfers.*
- *Strongly-ordered and Device transactions on page 5-23.*
- *Normal reads on page 5-26.*
- *Normal writes on page 5-27.*

Restrictions on AHBP interface transfers

The AHBP interface applies the following restrictions to the AHB transactions it generates:

- The interface only uses one transfer and all bursts are single, that is **HBURSTP[2:0]** is always SINGLE.
- No transaction ever crosses a 4-byte boundary in memory.
- The transfer type, that is, **HTRANSF[2:0]** is never BUSY or SEQUENTIAL.
- The transfer size is never greater than 32 bits because it is a 32-bit AHB bus.
- All transactions are data accesses, that is **HPROTP[0]** is always 1.
- Transactions to Device and Strongly-ordered memory are always to addresses that are aligned for the transfer size.
- Exclusive accesses are always to addresses that are aligned for the transfer size.

Strongly-ordered and Device transactions

A load or store instruction, to or from Strongly-ordered or Device memory, always generates AHB transactions of the size implied by the instruction. All accesses using LDM, STM, LDRD, or STRD instructions to Strongly-ordered or Device memory occur as single 32-bit transfers.

LDRB

Table 5-24 shows the values of **HADDRP[1:0]**, **HBURSTP**, and **HSIZEP** for an LDRB from bytes 0-3 in Strongly-ordered or Device memory.

Table 5-24 LDRB transfers

Address[1:0]	HADDRP[1:0]	HBURSTP	HSIZEP
0x0 (byte 0)	0x00	Single	8-bit
0x1 (byte 1)	0x01	Single	8-bit
0x2 (byte 2)	0x02	Single	8-bit
0x3 (byte 3)	0x03	Single	8-bit

LDRH

Table 5-25 shows the values of **HADDRP[1:0]**, **HBURSTP**, and **HSIZEP** for an LDRH from halfwords 0-1 in Strongly-ordered or Device memory.

Table 5-25 LDRH transfers

Address[1:0]	HADDRP[1:0]	HBURSTP	HSIZEP
0x0 (halfword 0)	0x00	Single	16-bit
0x2 (halfword 1)	0x02	Single	16-bit

Note

A load of a halfword from Strongly-ordered or Device memory addresses 0x1 or 0x3 generates an alignment UsageFault.

LDR or LDM of one register

Table 5-26 shows the values of **HADDRP[1:0]**, **HBURSTP**, and **HSIZEP** for an LDR or an LDM that transfers one register, an LDM1, in Strongly-ordered or Device memory.

Table 5-26 LDR or LDM of one register

Address[1:0]	HADDRP[1:0]	HBURSTP	HSIZEP
0x0 (word 0)	0x00	Single	32-bit

Note

A load of a word from Strongly-ordered or Device memory addresses 0x1, 0x02, 0x3, 0x5, 0x06, or 0x7 generates an alignment UsageFault.

LDM that transfers five registers

Table 5-27 shows the values of **HADDRP[1:0]**, **HBURSTP**, and **HSIZEP** for an LDM that transfers five registers, an LDM5, in Strongly-ordered or Device memory.

Table 5-27 LDM that transfers five registers

Address[1:0]	HADDRP[1:0]	HBURSTP	HSIZEP
0x0 (word 0)	0x00	Single	32-bit
	0x04	Single	32-bit
	0x08	Single	32-bit
	0x0C	Single	32-bit
	0x10	Single	32-bit
0x4 (word 1)	0x04	Single	32-bit
	0x08	Single	32-bit
	0x0C	Single	32-bit
	0x10	Single	32-bit
	0x14	Single	32-bit

Note

A load of a word from Strongly-ordered or Device memory addresses 0x1, 0x2, or 0x3 generates an alignment UsageFault.

STRB

Table 5-28 shows the values of **HADDRP[1:0]**, **HBURSTP**, and **HSIZEP** for an STRB from bytes 0-3 in Strongly-ordered or Device memory.

Table 5-28 STRB transfers

Address[1:0]	HADDRP[1:0]	HBURSTP	HSIZEP
0x0 (byte 0)	0x00	Single	8-bit
0x1 (byte 1)	0x01	Single	8-bit
0x2 (byte 2)	0x02	Single	8-bit
0x3 (byte 3)	0x03	Single	8-bit

STRH

Table 5-29 shows the values of **HADDRP[1:0]**, **HBURSTP**, and **HSIZEP** for an STRH from halfwords 0-1 in Strongly-ordered or Device memory.

Table 5-29 STRH transfers

Address[1:0]	HADDRP[1:0]	HBURSTP	HSIZEP
0x0 (halfword 0)	0x00	Single	16-bit
0x2 (halfword 1)	0x02	Single	16-bit

Note

A store of a halfword to Strongly-ordered or Device memory addresses 0x1 or 0x3 generates an alignment UsageFault.

STR of one register

Table 5-30 shows the values of **HADDRP[1:0]**, **HBURSTP**, and **HSIZEP** for an STR that transfers one register in Strongly-ordered or Device memory.

Table 5-30 STR of one register

Address[1:0]	HADDRP[1:0]	HBURSTP	HSIZEP
0x0 (word 0)	0x00	Single	32-bit

Note

A store of a word to Strongly-ordered or Device memory addresses 0x1, 0x2, or 0x3 generates an alignment UsageFault.

STM of five registers

Table 5-31 shows the values of **HADDRP[1:0]**, **HBURSTP**, and **HSIZEP** for an STM that transfers five registers, an STM5, over the AHB interface to Strongly-ordered or Device memory.

Table 5-31 STM of five registers

Address[1:0]	HADDRP[1:0]	HBURSTP	HSIZEP
0x0 (word 0)	0x00	Single	32-bit
	0x04	Single	32-bit
	0x08	Single	32-bit
	0x0C	Single	32-bit
	0x10	Single	32-bit

Table 5-31 STM of five registers (continued)

Address[1:0]	HADDRP[1:0]	HBURSTP	HSIZEP
0x4 (word 1)	0x04	Single	32-bit
	0x08	Single	32-bit
	0x0C	Single	32-bit
	0x10	Single	32-bit
	0x14	Single	32-bit

Note

A store of a word from Strongly-ordered or Device memory addresses 0x1, 0x2, 0x3, 0x5, 0x6, or 0x7 generates an alignment UsageFault.

Normal reads

Load instructions accessing Normal memory generate AHBP interface transactions that might not be the same size or length as the instruction implies. The tables in this section give examples of AHBP transactions that might result from various load instructions, accessing various addresses in Normal memory. They are examples only, and are not an exhaustive description of the AHBP transactions.

LDRH

Table 5-32 shows possible values of HADDRP[2:0], HBURSTP, and HSIZEP for an LDRH from bytes 0 to 3 in Normal memory.

Table 5-32 LDRH transfers in Normal memory

Address[1:0]	HADDRP[2:0]	HBURSTP	HSIZEP
0x0 (byte 0)	0x00	Single	16-bit
0x1 (byte 1)	0x00	Single	32-bit
0x2 (byte 2)	0x02	Single	16-bit
0x3 (byte 3) ^a	0x00	Single	32-bit
	0x04	Single	32-bit

a. AHBP interface transactions do not cross a double word boundary.

LDR

Table 5-33 shows possible values of **HADDRP[2:0]**, **HBURSTP**, and **HSIZEP** for an LDR from Normal memory.

Table 5-33 LDR transfers in Normal memory

Address[1:0]	HADDRP[2:0]	HBURSTP	HSIZEP
0x0 (byte 0)	0x0	Single	32-bit
0x1 (byte 1)	0x0	Single	32-bit
	0x4	Single	32-bit
0x2 (byte 2)	0x0	Single	32-bit
	0x4	Single	32-bit
0x3 (byte 3)	0x0	Single	32-bit
	0x4	Single	32-bit

Normal writes

Store instructions accessing Normal memory generate AHBP interface transactions that might not be the same size or length as the instruction implies. The tables in this section give examples of AHBP transactions that might result from various store instructions, accessing various addresses in Normal memory. They are examples only, and are not an exhaustive description of the AHBP transactions.

STRH

Table 5-34 shows possible values of **HADDRP[1:0]**, **HBURSTP**, and **HSIZEP** for an STRH from bytes 0 to 3 in Normal memory.

Table 5-34 STRH transfers in Normal memory

Address[1:0]	HADDRP[1:0]	HBURSTP	HSIZEP
0x0 (byte 0)	0x00	Single	16-bit
0x1 (byte 1)	0x01	Single	8-bit
	0x02	Single	8-bit
0x2 (byte 2)	0x02	Single	16-bit
0x3 (byte 3)	0x03	Single	8-bit
	0x04	Single	8-bit

STR or STM of one register

Table 5-35 shows possible values of **HADDRP[1:0]**, **HBURSTP**, and **HSIZEP** for an STR to Normal memory.

Table 5-35 STR transfers in Normal memory

Address[1:0]	HADDRP[1:0]	HBURSTP	HSIZEP
0x0 (byte 0, word 0)	0x00	Single	32-bit
0x1 (byte 1)	0x01	Single	8-bit
	0x02	Single	16-bit
	0x04	Single	8-bit
0x2 (byte 2)	0x02	Single	16-bit
	0x04	Single	16-bit
0x3 (byte 3)	0x03	Single	8-bit
	0x04	Single	16-bit
	0x06	Single	8-bit

5.5.2 AHBP semaphores

The peripheral interfaces use the internal exclusive monitor of the memory system to manage load, store and clear exclusive instructions to non-shared memory. The internal monitor checks exclusive accesses to shared memory and also, if necessary, any external monitor using the AHBP memory interface. You can use these instructions to construct semaphores and ensure synchronization between different processes or processors. See the *ARM[®]v7-M Architecture Reference Manual* for more information about how these instructions work.

Only exclusive instructions to shared memory result in exclusive accesses on the AHBP. Exclusive accesses to non-shared memory are marked as non-exclusive accesses on the bus.

The AHBP extension signals **EXREQP** and **EXRESPP** signal exclusive request and response for shared exclusive transactions on AHBP.

AHBP exclusive accesses

This section describes the **EXREQP** and **EXRESPP** signals and the transaction properties for AHBP exclusive accesses:

- **EXREQP** is an address phase signal and is only asserted when **HTRANSP** indicates a valid transaction.
- **EXRESPP** is a data phase signal and is only sampled on a data phase when **HREADYP** is 1.

The processor only asserts the **EXREQP** signal when:

- A load exclusive is performed to a Shared memory region on the AHBP.
- A store exclusive is performed to a Shared memory region on the AHBP and the internal exclusive access monitor passes. When the internal exclusive access monitor fails, no store is performed on the AHBP.

Table 5-36 shows the transaction properties the system must use for **EXRESPP**.

Table 5-36 Transaction properties

Transaction properties		Required EXRESPP
EXREQP	Load/Store	
0	Load/Store	-
1	Load	0 if a system monitor is implemented that covers the access address 1 otherwise
1	Store	1 if a system monitor is implemented that covers the access address and the exclusive check fails 0 otherwise

Software must avoid performing exclusive accesses to shared regions of memory if no global exclusive monitor is implemented that covers the region in question. The processor treats such accesses as an error condition and automatically takes a BusFault exception if a load is performed with **EXREQP** set to 1 and receives **EXRESPP** set to 1. The processor ignores **EXRESPP** for accesses that:

- Are performed with **EXREQP** set to 0. ARM recommends that the system drives **EXRESPP** to 0 in these cases.
- Return an error response on **HRESPP**.

The Cortex-M7 processor uses **EXREQP** and **EXRESPP** differently from the Cortex-M3 processor and the Cortex-M4 processor, therefore you might have to update both system hardware and software when moving to a system using the Cortex-M7 processor.

5.6 AHB slave interface

The 32-bit *AHB slave* (AHBS) interface provides system access to the ITCM, D1TCM, and D0TCM. It includes arbitration logic to support simultaneous system and processor TCM access requests. The AHBS implements the AMBA 3 AHB-Lite protocol.

Writes are buffered in the processor *Store Queue* (SQ). The SQ also buffers software writes to the TCM and it performs all stores in-order. Reads can be performed to the TCM out-of-order with respect to buffered writes.

If there is a data dependency between a read and a software or AHBS buffered write, hazarding logic stalls the read and attempts to drain the SQ until there are no longer any dependencies. Writes continue to be performed in-order. Hazarding is performed at byte granularity.

All AHBS accesses are treated as being the same endianness as memory. No data swizzling is performed for reads or writes.

The AHBS interface can be used when the processor is in sleep state.

5.6.1 Memory map

The memory map presented on the AHBS:

- Is consistent with the memory map presented to software running on the processor.

———— **Note** ————

The TCM enable bits, defined in the ITCMCR and DTCMCR, do not affect AHBS accesses and instead only affect software visibility of the TCMs, see [Instruction and Data Tightly-Coupled Memory Control Registers on page 3-13](#). AHBS accesses are handled independently of these bits.

- Has the additional restriction that only the TCM address range can be accessed. Any other addresses fail.

[Table 5-37](#) shows the AHBS memory map. Accesses to locations outside the address ranges shown return an error response on the AHBS interface.

Table 5-37 AHBS memory map

Start address	End address	HADDRS[2]	TCM accessed	TCM index
0x00000000	0x00000000 + <ITCM size>	-	ITCM	HADDRS[n:3] ^a
0x20000000	0x20000000 + <DTCM size>	0	D0TCM	HADDRS[n:3] ^a
0x20000000	0x20000000 + <DTCM size>	1	D1TCM	HADDRS[n:3] ^a

a. The value of n depends on the configured TCM size, see [TCM configuration on page 5-34](#).

5.6.2 Restrictions on AHBS transactions

Loopback of transactions from the AXIM or AHBP interface onto the AHBS is not supported because it might cause deadlock.

Note

Loopback arrangements are unlikely to be required. The processor has higher bandwidth to TCM than the AHBS interface. This means that software can directly transfer data to and from TCM faster than through the AHBS interface.

This restriction does not preclude arrangements where there is an indirect relationship between a master interface access and an AHBS access. For example, if a write from the AHBP interface requests an external agent to perform transactions on the AHBS interface. In this case do not introduce dependency in the system between the control access that initiates the transaction and the transaction itself.

AHBS interface transactions are not capable of performing MPU lookups. No distinction is made internally between unprivileged and privileged AHBS interface accesses as indicated on **HPROTS**. The system is entirely responsible for providing TCM protection functionality for AHBS interface accesses as required.

A TCM error mechanism must be used by the external TCM interface logic to indicate back to the AHBS interface that the access was aborted. In this case, the external TCM interface logic also mask writes and obfuscate read data. For more information on the TCM interface protocol, see *TCM interface protocol on page 5-34*.

The AHBS interface reads that are aborted on the TCM interface return the read data supplied with an error response on **HRESPS**. The AHBS interface writes are buffered and always return an OK response speculatively. If a write is subsequently aborted on the TCM interface, the AHBS raises an asynchronous abort to the system using the **WABORTS** signal.

The AHBS does not support exclusive or locked accesses and AHBS interface stores do not affect the state of the internal exclusive access monitor. This makes it unsuitable for systems requiring concurrency controls between the AHBS interface and software.

For more information on the TCM data sharing models supported between software and AHBS interface, see *System access to TCM on page 5-35*.

5.6.3 AHBS interface arbitration

There are two relevant points of arbitration in the processor:

- Accepting writes into the SQ from software and the AHBS interface.
- Performing TCM reads from software and the AHBS interface.

The processor supports five software-configurable arbitration modes:

- Round-robin only.
- Reduced AHBS interface bandwidth using the fairness counter.
- Reduced software bandwidth using the fairness counter.
- Round-robin but AHBS interface bandwidth is reduced using the fairness counter when execution priority is set above a defined threshold.
- Round-robin with AHBS interface bandwidth controlled by an input signal.

When active, the round-robin AHBS arbitration scheme has the following characteristics:

- Any requestor, that is, software or AHBS interface, is granted access when there is no contention. This scheme guarantees:
 - Optimal throughput for each requestor when contention is rare. In this case, the resource usage is not evenly balanced between requestors and one requestor is more active than the other. When contention is frequent however, the scheme used tends towards even resource allocation between the requestors.
 - Optimal average throughput across all requestors when contention is common.

The fairness counter determines which requestor gets access, where there is contention. This counter is decremented for each access where contention occurs, and is initialized to the CM7_AHBSR.INITCOUNT field value when it reaches 0. See [AHB Slave Control Register on page 3-20](#) for more information about how to use CM7_AHBSR.INITCOUNT.

Some limited software configurability is provided to moderate AHBS interface bandwidth by demoting its priority to a significantly lower level without shutting it out completely. This is achieved by increasing the initialization value of the fairness counter that forces arbitration of an AHBS interface access. It is also possible to invert the priority scheme to allow AHBS interface accesses to take priority over software accesses using the fairness counter.

Typically this AHBS interface bandwidth moderation feature is expected to be used for real-time critical code that runs in a high priority ISR. To allow individual ISRs to demote AHBS interface traffic, a *threshold execution priority* (TPRI) mode is provided to enable the processor hardware to automatically do this. See [AHB Slave Control Register on page 3-20](#) for more information about how to use TPRI.

———— **Note** —————

The processor could stop executing code if the counter initialization value is 0 and the AHBS interface fully occupies the bandwidth of a TCM or the SQ.

The system can control the AHBS interface access priority directly using the **AHBSPRI** input signal on the processor. See [AHB Slave Control Register on page 3-20](#).

———— **Note** —————

- Improper programming might directly degrade overall system performance.
- For the AHBS interface to accept AHBS transactions all resets must be de-asserted.
- Changes to CM7_AHBSR might not occur immediately because the processor must completed existing AHBS interface traffic.
- CM7_AHBSR settings can be overruled and only be considered as a hint to the processor.

5.7 TCM interfaces

The memory system includes support for the connection of local Tightly Coupled Memory called ITCM and DTCM. The ITCM has one 64-bit memory interface and the DTCM has two 32-bit memory interfaces, D0TCM and D1TCM, selected on bit[2] of the request address. Each TCM interface is a physical connection on the processor that is suitable for connection to SRAM with minimal glue logic. These ports are optimized for low-latency memory.

The TCM interfaces are designed to be connected to RAM, or RAM-like memory, that is, Normal-type memory in the ARM architecture. The processor can issue speculative read accesses on these interfaces. Therefore, read accesses through the TCM interfaces can be repeated, and can access uninitialized or nonexistent memory locations. This means that the TCM interfaces are generally not suitable for read-sensitive devices such as FIFOs. If an access is speculative, the processor ignores any error or retry signaled for the access, see [TCM interface protocol on page 5-34](#).

The TCM interfaces also have a wait signal to support slow memories, see [TCM interface protocol on page 5-34](#).

The *Prefetch Unit* (PFU) can fetch instructions from any of the TCM interfaces. The *Load Store Unit* (LSU) and the AHBS interface can each read and write data using any of the TCM interfaces. Best performance is achieved if code is placed in ITCM and data in DTCM. However, there is no functional restriction in which TCM, code and data is placed.

Each TCM interface has a fixed base address, see [System address map on page 2-5](#).

This section describes:

- [TCM attributes and permissions](#).
- [TCM configuration on page 5-34](#).
- [TCM arbitration on page 5-34](#).
- [TCM interface protocol on page 5-34](#).
- [TCM read modify write on page 5-35](#).

5.7.1 TCM attributes and permissions

Accesses to the TCMs from the LSU and PFU are checked against the MPU for access permission. Memory access attributes and permissions are not exported on this interface. Any unaligned access to Device or Strongly Ordered memory generates an alignment UsageFault. Reads that generate an MPU fault or alignment UsageFault are still sent to the TCM interface, but the data is not used and the associated load instruction does not update any processor registers, ensuring protection is maintained. Writes that generate an MPU fault or alignment UsageFault are never broadcast on the TCM interface.

TCMs always behave as Non-cacheable Non-shared Normal memory, irrespective of the memory type attributes defined in the MPU for a memory region containing addresses held in the TCM. Access permissions associated with an MPU region in the TCM address space are treated in the same way as addresses outside the TCM address space. For more information about memory attributes, types, and permissions, see the *ARM[®]v7-M Architecture Reference Manual*.

———— **Note** —————

For code portability to other ARM processors or systems, ARM recommends that TCM regions are always defined as Normal, Non-shared memory in the MPU. This is consistent with the default ARMv7E-M memory map attributes that apply when the MPU is either disabled or not implemented.

5.7.2 TCM configuration

The base address of each TCM is fixed:

- ITCM at 0x00000000.
- DTCM at 0x20000000.

The ITCM and DTCM occupy the lower parts of the code and data regions of the memory map respectively, see [System address map on page 2-5](#).

The size of each TCM is configured during integration from 4KB to 16MB in powers of two. If a TCM is not present in a system, its size is 0KB.

The DTCM has two interfaces, D0TCM and D1TCM. This means the size of the RAM attached to each interface is half the total size of the DTCM.

The size of the TCMs is visible to software in the TCM Control Registers, see [Instruction and Data Tightly-Coupled Memory Control Registers on page 3-13](#). Memory accesses to addresses above the implemented TCM address ranges in the code and data regions of the memory map are sent to the AXIM interface.

The ITCM and DTCM can be enabled or disabled by software using the ITCMCR.EN and DTCMCR.EN bits. See [Instruction and Data Tightly-Coupled Memory Control Registers on page 3-13](#). Input configuration signals determine the values of these bits out of reset.

5.7.3 TCM arbitration

The TCU contains arbitration logic to arbitrate between TCM access requests for the LSU, PFU, AHBS and SQ. In most cases, the LSU has the highest priority, followed by the PFU, AHBS, and the SQ having the lowest priority.

When a higher-priority requestor is accessing a TCM, an access from a lower-priority device stalls.

In some circumstances the SQ can have the highest priority temporarily, for example, when a RAW hazard occurs because of a load from the same address as a store in the SQ. This ensures that the hazard is cleared as quickly as possible allowing the load to proceed. The AHBS interface might have the highest priority because of AHBS priority boosting, see [AHBS interface arbitration on page 5-31](#). If the SQ and AHBS are priority boosted at the same time, the SQ then has the highest priority.

5.7.4 TCM interface protocol

Each TCM interface operates independently of each other, and each might perform either a read or a write access in a particular clock cycle. In addition to the address and data signals, the TCM interfaces also provide information about the source of an access and whether it is privileged or not. Therefore, it is possible to determine whether an access results from an instruction fetch from the PFU, a data access from the LSU, an SQ access, an MBIST interface access, or a DMA transfer from the AHBS interface.

During read accesses, an external TCM memory controller can indicate that the processor must wait one or more clock cycles before capturing the read data from the interface. The controller can also indicate that an error occurred during a read or a write access and that the processor must take a bus fault. The controller might, for example, use this error to indicate a privilege violation by decoding the address, privilege indication, or access source information. For more information about TCM errors, see [Faults on page 5-3](#).

If the TCM memory controller supports ECC error detection and correction it can indicate to the processor that an access must be retried to return the corrected data. The TCM retry functionality in the processor must be enabled to support external TCM error correction by setting the ITCMCR.RETEN or DTCMCR.RETEN bits to 1. See *Instruction and Data Tightly-Coupled Memory Control Registers* on page 3-13.

5.7.5 TCM read modify write

Read modify write can be enabled on the TCM interfaces by setting the ITCMCR.RMW or DTCMCR.RMW bits to 1, see *Instruction and Data Tightly-Coupled Memory Control Registers* on page 3-13. When enabled, the processor uses the read modify write sequence for writes that have a data size that are less than the width of the interface. This feature is intended to be used in systems that implement ECC in TCM.

5.7.6 Booting from TCM

The following support is available for booting volatile TCM memory that must be initialized at reset:

- The TCMs can be enabled from reset independently of software, using configuration input signals.
- When the **CPUWAIT** signal is asserted HIGH from reset, it prevents the processor initiating its normal hardware bootup routine. This allows the TCMs to be loaded by system hardware before the processor performs any TCM accesses. When TCM loading is complete the signal is deasserted to allow the processor to boot up.
- The processor AHBS port functions while **CPUWAIT** is asserted and services transactions to load the TCMs initiated by system hardware. This avoids requiring external hardware on the TCM interface for boot-time initialization.

5.7.7 Integration with Flash memory

When executing 32-bit instructions, the processor execution bandwidth can be as high as 64 bits per cycle. For 16-bit instructions, it can be as high as 32 bits per cycle. The overall bandwidth is very application specific, however, for general-purpose products, assume 64 bits per cycle is required. The I-side memory system must sustain this bandwidth for maximum performance. ARM recommends that if Flash is integrated on the ITCM interface, you use a system cache or Flash accelerator to satisfy these fetch bandwidth requirements.

Alternatively, Flash can be integrated on the AXIM and the processor can be configured to include the I-cache.

5.7.8 System access to TCM

The AHBS interface provides system access to the TCMs even when the processor is running. Arbitration between software and AHBS accesses to the TCMs is supported without requiring external TCM interface logic.

There is no hardware support for concurrency control between software and AHBS access to the TCMs. In particular, software exclusive accesses to the TCMs is only subject to the internal exclusive monitor that does not take AHBS accesses into account. This implies that the system must not perform AHBS accesses to any regions of TCM memory that are used with software exclusive accesses.

However, it is possible to share data coherently between software running on the processor and the system using the AHBS interface and with the following processor hardware guarantees:

- Writes to the TCMs by software or AHBS are never repeated.

———— **Note** ————

Store multiple instructions and unaligned single stores can be repeated on exception return and are therefore exempt from this guarantee and unsuitable for software synchronization. The processor guarantees that no single-copy-atomic access is repeated. For more information on atomicity, see the *ARM[®]v7-M Architecture Reference Manual*.

- Writes to a TCM by both software and AHBS have a single point of serialization, the TCM Store Queue. This means that when a write is observable by one master, it is guaranteed observable by the other.
- When a write on the AHBS interface is accepted, its data phase completes with an OK response, the processor assumes responsibility for the coherent observation of that data item. A read initiated by either master after the AHBS write completes, returns the updated data.

———— **Note** ————

TCMs are implicitly Normal memory, and therefore write buffering is permitted. A completed AHBS write does not imply that the write was performed on the TCM interface, but instead that it successfully entered the Store Queue. Therefore, if all writes are required to have been committed to memory first, the system must avoid resetting the processor until the Store Queue has drained.

The standard message passing model for data sharing can be used. The ARM architecture requires this model to work where coherency is supported, and is therefore portable to other ARM processors.

Table 5-38 shows the standard message passing software protocol.

Table 5-38 Standard message passing software protocol

Data generator	Data consumer
STR <data>	LDR <valid>
DMB	LOOP until <valid> set
STR <valid>	LDR <data>

———— **Note** ————

- Interrupt-based synchronization on the processor is possible when the AHBS interface is used to transfer system-generated data. In this model, an interrupt is generated when the AHBS completes the last data transfer. The first instruction in the ISR is guaranteed to observe any data items stored before, or on this transfer. In this case, the completion of the last AHBS access indicates global observability, instead of having to perform a software read of the location and waiting until it updates.
- This scheme is not guaranteed to be supported on other ARM processors and you must use it with care when you require code portability.

5.8 L1 caches

This section describes the behavior of the optional L1 caches in the Cortex-M7 processor memory system.

The memory system is configured during implementation and can include instruction and data caches of varying sizes. You can configure whether each cache controller is included and, if it is, configure the size of each cache independently. The cached instructions or data are fetched from external memory using the AXIM interface. The cache controllers use RAMs that are integrated into the Cortex-M7 processor during implementation.

Any access that is not for a TCM or the AHBP interface is handled by the appropriate cache controller. If the access is to Non-shared cacheable memory, and the cache is enabled, a lookup is performed in the cache and, if found in the cache, that is, a cache hit, the data is fetched from or written into the cache. When the cache is not enabled and for Non-cacheable or Shared memory the accesses are performed using the AXIM interface.

Both caches allocate a memory location to a cache line on a cache miss because of a read, that is, all cacheable locations are Read-Allocate. In addition, the data cache can allocate on a write access if the memory location is marked as Write-Allocate. When a cache line is allocated, the appropriate memory is fetched into a linefill buffer by the AXIM interface before being written to the cache. The linefill buffers always fetch the requested data first, return it, and fetch the rest of the cache line. This enables the data read without waiting for the linefill to complete and is known as *critical word first* and *non-blocking* behavior. If subsequent instructions require data from the same cache line, this can also be returned when it has been fetched without waiting for the linefill to complete, that is, the caches also support *streaming*. If an error is reported to the AXIM interface for a linefill, the linefill does not update the cache RAMs.

A synchronous fault is generated if the faulting data is used by a non-speculative read in the processor. An asynchronous fault is generated by a line-fill when an external fault occurs if write data from an address configured as Write-Back has been merged into the line from the store buffer. See [Store buffer on page 5-38](#).

The data cache is four-way set-associative, the instruction cache is two-way set-associative. Both caches use a line-length of 32-bytes. If all the cache lines in a set are valid, to allocate a different address to the cache, the cache controller must evict a line from the cache.

Writes accesses that hit in the data cache are written into the cache RAMs. If the memory location is marked as Write-Through, the write is also performed on the AXIM interface, so that the data stored in the RAM remains coherent with the external memory system. If the memory is Write-Back, the cache line is marked as dirty, and the write is only performed on the AXIM interface when the line is evicted. When a dirty cache line is evicted, the data is passed to the write buffer in the AXIM interface to be written to the external memory system.

The cache controllers also manage the cache maintenance operations described in [Cache maintenance operations on page 5-39](#).

Each cache can also be configured with ECC. If ECC is implemented and enabled, then the tags associated with each line, and data read from the cache are checked whenever a lookup is performed in the cache and, if possible, the data is corrected before being used in the processor. A full description of ECC error checking and correction is beyond the scope of this document. Contact ARM if you require more information.

For more information on the general rules about memory attributes and behavior, see the *ARM[®]v7-M Architecture Reference Manual*.

5.8.1 Dynamic read allocate mode

When a memory region is marked as Write-Back Write-Allocate, it normally allocates a cache line on either a read miss or a write miss. However, there are some situations where allocating on writes is undesirable, such as executing the C standard library `memset()` function to clear a large block of memory to a known value. Writing large blocks of data like this can pollute the cache with unnecessary data. It can also waste power and performance if a linefill must be performed only to discard the linefill data because the entire line was subsequently written by the `memset()`.

To prevent this, the *Cortex-M7 Bus Interface Unit (BIU)* includes logic to detect when a full cache line has been written by the core before the linefill has completed. If this situation is detected on three consecutive linefills, it switches into dynamic read allocate mode. When in dynamic read allocate mode, loads behave as normal and can still cause linefills, and writes still lookup in the cache but, if they miss, they write out to external memory rather than starting a linefill.

The BIU continues in dynamic read allocate mode until it detects either a cacheable write burst to external memory that is not a full cache line, or there is a load to the same line as is currently being written to external memory.

Dynamic read allocate mode can be disabled by setting the `ACTLR.DISRAMODE` to 1. See [Auxiliary Control Register on page 3-6](#).

5.8.2 Store buffer

The memory system includes a store buffer to hold data before it is written to the cache RAMs or passed to the AXIM interface. The store buffer has four entries. Each entry can contain up to 64 bits of data and a 32-bit address. All write requests from the data-side that are not to a TCM or the AHBP interface are stored in the store buffer.

Store buffer merging

The store buffer has merging capabilities. If a previous write access has updated an entry, other write accesses on the same line can merge into this entry. Merging is only possible for stores to Normal memory.

Merging is possible between several entries that can be linked together if the data inside the different entries belong to the same cache line.

No merging occurs for writes to Strongly-ordered or Device memory. The processor automatically drains the store buffer as necessary before performing Strongly-ordered or Device reads.

Store buffer behavior

The store buffer directs write requests to the following blocks:

- Cache controller for cacheable write hits:
 - The store buffer sends a cache lookup to check that the cache hits in the specified line, and if so, the store buffer merges its data into the cache when the entry is drained.
- AXIM interface:
 - For Non-cacheable, Write-Through Cacheable, Write-Back no Write-Allocate Cacheable stores that miss in the data cache, a write access is performed on the AXIM interface.

- For Write-Back, Write-Allocate stores that miss in the data cache, a linefill is started using either of the two linefill buffers. When the linefill data is returned from the external memory system, the data in the store buffer is merged into the linefill buffer and subsequently written into the cache.

Store buffer draining

A store buffer entry is drained if:

- All bytes in the entry have been written. This might result from merging.
- The entry can be merged into a linefill buffer.
- The entry contains a store to Device or Strongly-ordered memory.
- The entry is Non-cacheable or Write-Through and has been waiting for merge data for too long.

The store buffer is completely drained when:

- An explicit drain request is done for:
 - Cache maintenance operations.
 - A DMB or DSB instruction.
 - An exclusive store to Shared memory.
- The store buffer is full or likely to become full.

The store buffer is drained of all stores to Strongly-ordered or Device memory before a load is performed from Strongly-ordered or Device memory.

5.8.3 Cache maintenance operations

All cache maintenance operations are executed by writing to registers in the memory-mapped *System Control Space* (SCS) region of the internal PPB memory space. The operations supported for the data cache are:

- Invalidate by address.
- Invalidate by Set/Way combination.
- Clean by address.
- Clean by Set/Way combination.
- Clean and Invalidate by address.
- Clean and Invalidate by Set/Way combination.

The operations supported for the instruction cache are:

- Invalidate all.
- Invalidate by address.

For more information see *ARM[®]v7-M Architecture Reference Manual*.

5.8.4 Cache interaction with memory system

After you enable or disable the instruction cache, you must issue an ISB instruction to flush the pipeline. This ensures that all subsequent instruction fetches see the effect of enabling or disabling the instruction cache.

After reset, you must invalidate each cache before enabling it.

When disabling the data cache, you must clean the entire cache to ensure that any dirty data is flushed to external memory.

Before enabling the data cache, you must invalidate the entire data cache because external memory might have changed from when the cache was disabled.

Before enabling the instruction cache, you must invalidate the entire instruction cache if external memory might have changed since the cache was disabled.

See [Chapter 4 Initialization](#) for example code suitable for initializing and enabling the instruction and data caches.

Chapter 6

Memory Protection Unit

This chapter describes the *Memory Protection Unit* (MPU). It contains the following sections:

- *About the MPU* on page 6-2.
- *MPU functional description* on page 6-3.
- *MPU programmers model* on page 6-4.

6.1 About the MPU

The MPU is an optional component for memory protection. The processor supports the standard ARMv7 *Protected Memory System Architecture* model. The MPU provides full support for:

- Eight or sixteen protection regions.
- Overlapping protection regions, with ascending region priority:
 - 15** Highest priority, when 16 regions are implemented.
 - 7** Highest priority, when 8 regions are implemented.
 - 0** Lowest priority.
- Access permissions.
- Exporting memory attributes to the system.

MPU mismatches and permission violations invoke the programmable-priority MemManage fault handler. See the *ARM[®]v7-M Architecture Reference Manual* for more information.

You can use the MPU to:

- Enforce privilege rules.
- Separate processes.
- Enforce access rules.

6.2 MPU functional description

The access permission bits, TEX, C, B, AP, and XN, of the Region Attributes and Size Register, MPU_RASR, control access to the corresponding memory region. If an access is made to an area of memory without the required permissions, a MemManage fault is raised. For more information, see the *ARM[®]v7-M Architecture Reference Manual*.

6.3 MPU programmers model

Table 6-1 shows the MPU registers. These registers are described in the *ARM®v7-M Architecture Reference Manual*.

Table 6-1 MPU registers

Address	Name	Type	Reset	Description
0xE000ED90	MPU_TYPE	RO	0x00000800 ^a	MPU Type Register
0xE000ED94	MPU_CTRL	RW	0x00000000	MPU Control Register
0xE000ED98	MPU_RNR	RW	Unknown	MPU Region Number Register
0xE000ED9C	MPU_RBAR	RW	Unknown	MPU Region Base Address Register
0xE000EDA0	MPU_RASR	RW	Unknown	MPU Region Attribute and Size Register
0xE000EDA4	MPU_RBAR_A1	RW	Unknown	MPU alias registers
0xE000EDA8	MPU_RASR_A1	RW	Unknown	
0xE000EDAC	MPU_RBAR_A2	RW	Unknown	
0xE000EDB0	MPU_RASR_A2	RW	Unknown	
0xE000EDB4	MPU_RBAR_A3	RW	Unknown	
0xE000EDB8	MPU_RASR_A3	RW	Unknown	

a. The reset value depends on the number of regions implemented:

0x00000000	0 regions.
0x00000800	8 regions.
0x00001000	16 regions.

Note

The MPU registers support aligned word accesses only. Byte and halfword accesses are UNPREDICTABLE.

Chapter 7

Nested Vectored Interrupt Controller

This chapter describes the *Nested Vectored Interrupt Controller* (NVIC). It contains the following sections:

- *About the NVIC* on page 7-2.
- *NVIC functional description* on page 7-3.
- *NVIC programmers model* on page 7-4.

7.1 About the NVIC

The NVIC provides configurable interrupt handling abilities to the processor. It:

- Facilitates low-latency exception and interrupt handling.
- Controls power management.

7.2 NVIC functional description

The NVIC supports up to 240 interrupts each with up to 256 levels of priority. You can change the priority of an interrupt dynamically. The NVIC and the processor core interface are closely coupled, to enable low-latency interrupt processing and efficient processing of late arriving interrupts. The NVIC maintains knowledge of the stacked, or nested, interrupts to enable tail-chaining of interrupts.

You can only fully access the NVIC from privileged mode, but you can cause interrupts to enter a pending state in user mode if you enable the Configuration and Control Register. Any other user mode access causes a bus fault.

You can access all NVIC registers using only word accesses. For more information on NVIC registers accessibility and their usage constraints, see the *ARM®v7-M Architecture Reference Manual*.

Processor exception handling is described in [Exceptions on page 2-9](#).

7.2.1 Low power modes

Your implementation can include a *Wake-up Interrupt Controller* (WIC). This enables the processor and NVIC to be put into a very low-power sleep mode leaving the WIC to identify and prioritize interrupts. When the WIC is used, you must enable SLEEPDEEP in the System Control Register.

The processor fully implements the *Wait For Interrupt* (WFI), *Wait For Event* (WFE), and the *Send Event* (SEV) instructions. In addition, the processor also supports the use of SLEEPONEXIT, that causes the processor core to enter sleep mode when it returns from an exception handler to Thread mode. See the *ARM®v7-M Architecture Reference Manual* for more information.

7.2.2 Level versus pulse interrupts

The processor supports both level and pulse interrupts. A level interrupt is held asserted until it is cleared by the ISR accessing the device. A pulse interrupt is a variant of an edge model. You must ensure that the pulse is sampled on the rising edge of the processor clock, **FCLK**, instead of being asynchronous.

For level interrupts, if the signal is not deasserted before the return from the interrupt routine, the interrupt again enters the pending state and re-activates. This is particularly useful for FIFO and buffer-based devices because it ensures that they drain either by a single ISR or by repeated invocations, with no extra work. This means that the device holds the signal in assert until the device is empty.

A pulse interrupt can be reasserted during the ISR so that the interrupt can be in the pending state and active at the same time. If another pulse arrives while the interrupt is still pending, the interrupt remains pending and the ISR runs only once.

Pulse interrupts are mostly used for external signals and for rate or repeat signals.

7.3 NVIC programmers model

This section describes the NVIC registers whose implementation is specific to this processor. Other registers are described in the *ARM[®]v7-M Architecture Reference Manual*. [Table 7-1](#) shows the NVIC registers.

Table 7-1 NVIC registers

Address	Name	Type	Reset	Description
0xE000E004	ICTR	RO	-	<i>Interrupt Controller Type Register</i>
0xE000E100-0xE000E11C	NVIC_ISER0-NVIC_ISER7	RW	0x00000000	Interrupt Set-Enable Registers
0xE000E180-0xE000E19C	NVIC_ICER0-NVIC_ICER7	RW	0x00000000	Interrupt Clear-Enable Registers
0xE000E200-0xE000E21C	NVIC_ISPR0-NVIC_ISPR7	RW	0x00000000	Interrupt Set-Pending Registers
0xE000E280-0xE000E29C	NVIC_ICPR0-NVIC_ICPR7	RW	0x00000000	Interrupt Clear-Pending Registers
0xE000E300-0xE000E31C	NVIC_IABR0-NVIC_IABR7	RO	0x00000000	Interrupt Active Bit Register
0xE000E400-0xE000E4EC	NVIC_IPR0-NVIC_IPR59	RW	0x00000000	Interrupt Priority Register

7.3.1 Interrupt Controller Type Register

The ICTR characteristics are:

Purpose Shows the number of interrupt lines that the NVIC supports.

Usage Constraints There are no usage constraints.

Configurations Available in all configurations.

Attributes See the register summary in [Table 7-1](#).

[Figure 7-1](#) shows the ICTR bit assignments.

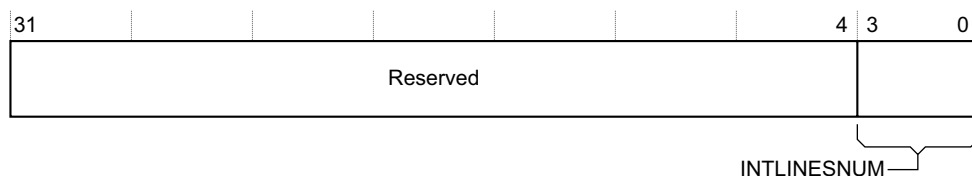

Figure 7-1 ICTR bit assignments

Table 7-2 shows the ICTR bit assignments.

Table 7-2 ICTR bit assignments

Bits	Name	Function
[31:4]	-	Reserved.
[3:0]	INTLINESNUM	Total number of interrupt lines in groups of 32:
	0b0000	0-32.
	0b0001	33-64.
	0b0010	65-96.
	0b0011	97-128.
	0b0100	129-160.
	0b0101	161-192.
	0b0110	193-224.
	0b0111	225-256 ^a .

a. The processor supports a maximum of 240 external interrupts.

Chapter 8

Floating Point Unit

This chapter describes the *Floating Point Unit* (FPU). It contains the following sections:

- *About the FPU* on page 8-2.
- *FPU functional description* on page 8-3.
- *FPU programmers model* on page 8-5.

8.1 About the FPU

The Cortex-M7 processor with FPU is an implementation of the single-precision and double-precision variant of the ARMv7-M Architecture with Floating-Point Extension (FPv5).

The FPv5 extensions features are:

- Addition of double-precision operand support for existing data processing instructions in FPv4-SP-D16-M.
- Some new instructions for both double and single-precision operands.
- 16 double-precision registers. This is the same as for FPv4 and there are no additional registers.
- Software-enable control for single-precision and double-precision support using CPACR.
- Double-precision and single-precision support, when both are implemented, cannot be enabled independently of one another.
- Identical load/store instruction support to FPv4 extensions that already includes support for 64-bit data types.

Table 8-1 shows the ISA supported for the different configurations of the Cortex-M7 processor.

Table 8-1 Cortex-M7 ISA Support

Configuration	ISA supported
Processor with no floating-point	v7E-M
Processor with single-precision floating-point	v7E-M + FPv5-SP-D16-M
Processor with single-precision and double-precision floating-point	v7E-M + FPv5-DP-D16-M

It provides floating-point computation functionality that is compliant with the *ANSI/IEEE Std 754-2008, IEEE Standard for Binary Floating-Point Arithmetic*, referred to as the IEEE 754 standard.

8.2 FPU functional description

This section describes the operations and that the FPU supports and what exceptions the FPU generates.

The FPU fully supports single-precision and double-precision add, subtract, multiply, divide, multiply and accumulate, and square root operations. It also provides conversions between fixed-point and floating-point data formats, and floating-point constant instructions.

The FPU provides an extension register file containing 32 single-precision registers. These can be viewed as:

- Sixteen 64-bit doubleword registers, D0-D15.
- Thirty-two 32-bit single-word registers, S0-S31.
- A combination of registers from these views.

For more information about the FPU, see the *ARM[®]v7-M Architecture Reference Manual*.

This section contains the following:

- [Modes of operation](#).
- [Compliance with the IEEE 754 standard on page 8-4](#).
- [Exceptions on page 8-4](#).

The modes of operation are controlled using the Floating-Point Status and Control Register, FPSCR. For more information about the FPSCR see the *ARMv7-M Architecture Reference Manual*.

8.2.1 Modes of operation

The FPU provides three modes of operation to accommodate a variety of applications:

- [Full-compliance mode](#).
- [Flush-to-zero mode](#).
- [Default NaN mode](#).

Full-compliance mode

In full-compliance mode, the FPU processes all operations according to the IEEE 754 standard in hardware.

Flush-to-zero mode

Setting the FPSCR.FZ bit enables flush-to-zero mode. In this mode, the FPU treats all subnormal input operands of arithmetic operations as zeros in the operation. Exceptions that result from a zero operand are signaled appropriately. VABS, VNEG, and VMOV are not considered arithmetic operations and are not affected by flush-to-zero mode. A result that is *tiny*, as described in the IEEE 754 standard, where the destination precision is smaller in magnitude than the minimum normal value *before rounding*, is replaced with a zero. The FPSCR.IDC bit indicates when an input flush occurs. The FPSCR.UFC bit indicates when a result flush occurs.

Default NaN mode

Setting the FPSCR.DN bit enables default NaN mode. In this mode, the result of any arithmetic data processing operation that involves an input NaN, or that generates a NaN result, returns the default NaN. Propagation of the fraction bits is maintained only by VABS, VNEG, and VMOV operations. All other arithmetic operations ignore any information in the fraction bits of an input NaN.

8.2.2 Compliance with the IEEE 754 standard

When *Default NaN* (DN) and *Flush-to-Zero* (FZ) modes are disabled, FPv5 functionality is compliant with the IEEE 754 standard in hardware. No support code is required to achieve this compliance.

See the *ARM[®]v7-M Architecture Reference Manual* for information about FP architecture compliance with the IEEE 754 standard.

8.2.3 Exceptions

The FPU sets the cumulative exception status flag in the FPSCR register as required for each instruction, in accordance with the FPv5 architecture. The FPU does not support exception traps. The processor also has six output pins, **FPIXC**, **FPUFC**, **FPOFC**, **FPDZC**, **FPIDC**, and **FPIOC**, that each reflect the status of one of the cumulative exception flags.

The processor can reduce the exception latency by using lazy stacking. This means that the processor reserves space on the stack for the FP state, but does not save that state information to the stack until it is required to do so. See the *ARM[®]v7-M Architecture Reference Manual* for more information.

8.3 FPU programmers model

Table 8-2 shows the floating-point system registers in the Cortex-M7 processor with FPU, when implemented. These registers are described in the *ARM[®] v7-M Architecture Reference Manual*.

Table 8-2 Floating-point system registers

Address	Name	Type	Reset	Description
0xE00EF34	FPCCR	RW	0xC0000000	Context Control Register
0xE00EF38	FPCAR	RW	-	Context Address Register
0xE00EF3C	FPDSCR	RW	0x00000000	Default Status Control Register
0xE00EF40	MVFR0	RO	0x10110021 ^a 0x10110221 ^b	Media and VFP Feature Register 0
0xE00EF44	MVFR1	RO	0x11000011 ^a 0x12000011 ^b	Media and VFP Feature Register 1
0xE00EF48	MVFR2	RO	0x00000040	Media and VFP Feature Register 2

a. Single-precision only FPU.

b. Single-precision and double-precision FPU.

Chapter 9

Debug

This chapter describes how to debug and test software running on the processor. It contains the following sections:

- [About debug on page 9-2.](#)
- [About the AHBD interface on page 9-7.](#)
- [About the FPB on page 9-8.](#)

9.1 About debug

Cortex-M7 debug functionality includes processor halt, single-step, processor core register access, Vector Catch, unlimited software breakpoints, and full system memory access. See the *ARM[®]v7-M Architecture Reference Manual* for more information. The processor also includes support for hardware breakpoints and watchpoints configured during implementation:

- A breakpoint unit supporting four to eight instruction comparators.
- A watchpoint unit supporting two or four watchpoints.

For processors that implement debug, ARM recommends that a debugger identify and connect to the debug components using the CoreSight debug infrastructure.

Figure 9-1 shows the recommended flow that a debugger can follow to discover the components in the CoreSight debug infrastructure. In this case a debugger reads the peripheral and component ID registers for each CoreSight component in the CoreSight system.

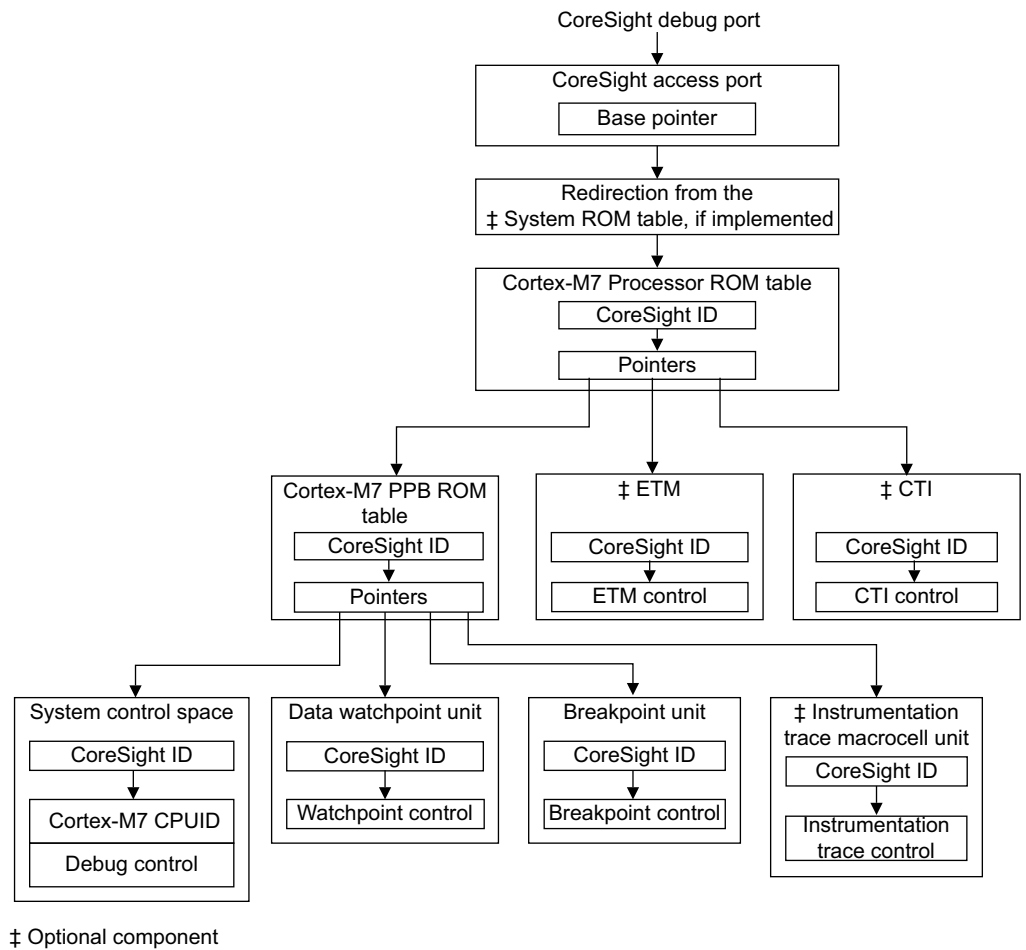

Figure 9-1 CoreSight discovery

To identify the Cortex-M7 processor within the CoreSight system, ARM recommends that a debugger perform the following actions:

1. Locate and identify the Cortex-M7 Processor ROM table using its CoreSight identification. See [Table 9-2 on page 9-4](#) for more information.

2. Follow the pointer in the Cortex-M7 Processor ROM table to the Cortex-M7 PPB ROM table. From the PPB ROM table pointers the following components can be identified:
 - a. *System Control Space (SCS)*.
 - b. *Breakpoint unit (FPB)*.
 - c. *Data Watchpoint and Trace unit (DWT)*.
 - d. *Instrumentation Trace Macrocell unit (IMT)*.

See [Table 9-4 on page 9-5](#) for more information.

When a debugger identifies the SCS from its CoreSight identification, it can identify the processor and its revision number from the CPUID register in the SCS at address 0xE000ED00.

A debugger cannot rely on the Cortex-M7 Processor ROM table being the first ROM table encountered. One or more system ROM tables are required between the access port and the processor ROM table if other CoreSight components are in the system. If a system ROM table is present, this can include a unique identifier for the implementation.

9.1.1 Cortex-M7 Processor ROM table identification and entries

[Table 9-1](#) shows the processor ROM table identification registers and values for debugger detection. This permits debuggers to identify the processor.

Table 9-1 Cortex-M7 Processor ROM table identification values

Address	Register	Value	Description
0xE00FEFD0	Peripheral ID4	0x00000004	<i>Component and Peripheral ID register formats in the ARM®v7-M Architecture Reference Manual</i>
0xE00FEFD4	Peripheral ID5	0x00000000	
0xE00FEFD8	Peripheral ID6	0x00000000	
0xE00FEFDC	Peripheral ID7	0x00000000	
0xE00FEFE0	Peripheral ID0	0x000000C8	
0xE00FEFE4	Peripheral ID1	0x000000B4	
0xE00FEFE8	Peripheral ID2	0x0000000B	
0xE00FEFEC	Peripheral ID3	0x00000000	
0xE00FEFF0	Component ID0	0x0000000D	
0xE00FEFF4	Component ID1	0x00000010	
0xE00FEFF8	Component ID2	0x00000005	
0xE00FEFFC	Component ID3	0x000000B1	

These values for the Peripheral ID registers identify this as the Cortex-M7 Processor ROM table. The Component ID registers identify this as a CoreSight ROM table.

Note

The Cortex-M7 Processor ROM table only supports word-size transactions.

Table 9-2 shows the CoreSight components that the Cortex-M7 Processor ROM table points to.

Table 9-2 Cortex-M7 Processor ROM table components

Address	Component	Value	Description
0xE00FE000	Cortex-M7 PPB ROM Table	0x00001003	See Cortex-M7 PPB ROM table identification and entries
0xE00FE004	ETM	0xFFF43003 ^a	See the <i>ARM® CoreSight™ ETM-M7 Technical Reference Manual</i>
0xE00FE008	CTI	0xFFF44003 ^b	See Chapter 10 Cross Trigger Interface
0xE00FE00C	Reserved	0x1FF02002	See the <i>ARM® CoreSight™ Architecture Specification (v2.0)</i>
0xE00FE010	End marker	0x00000000	
0xE00FEFCC	SYSTEM ACCESS	0x00000001	

- a. Reads as 0xFFF43002 if the ETM is not implemented.
 b. Reads as 0xFFF44002 if the CTI is not implemented.

The Cortex-M7 Processor ROM table entries point to the debug components of the processor. The offset for each entry is the offset of that component from the ROM table base address, 0xE00FE000.

See the *ARM® CoreSight™ Architecture Specification (v2.0)* for more information about the ROM table ID and component registers, and access types.

9.1.2 Cortex-M7 PPB ROM table identification and entries

Table 9-3 shows the Cortex-M7 PPB ROM table identification registers and values for debugger detection. This permits debuggers to identify the CoreSight components on the PPB in the processor and their debug capabilities.

Table 9-3 Cortex-M7 PPB ROM table identification values

Address	Register	Value	Description
0xE00FFFD0	Peripheral ID4	0x00000004	<i>Component and Peripheral ID register formats in the ARM®v7-M Architecture Reference Manual</i>
0xE00FFFD4	Peripheral ID5	0x00000000	
0xE00FFFD8	Peripheral ID6	0x00000000	
0xE00FFFD4	Peripheral ID7	0x00000000	
0xE00FFFE0	Peripheral ID0	0x000000C7	
0xE00FFFE4	Peripheral ID1	0x000000B4	
0xE00FFFE8	Peripheral ID2	0x0000000B	
0xE00FFFE4	Peripheral ID3	0x00000000	
0xE00FFF00	Component ID0	0x0000000D	
0xE00FFF04	Component ID1	0x00000010	
0xE00FFF08	Component ID2	0x00000005	
0xE00FFF0C	Component ID3	0x000000B1	

These values for the Peripheral ID registers identify this as the Cortex-M7 PPB ROM table. The Component ID registers identify this as a CoreSight ROM table.

———— **Note** ————

The Cortex-M7 PPB ROM table only supports word size transactions.

Table 9-4 shows the CoreSight components that the Cortex-M7 PPB ROM table points to. The values depend on the implemented debug configuration.

Table 9-4 Cortex-M7 PPB ROM table components

Address	Component	Value	Description
0xE00FF000	SCS	0xFFF0F003	See <i>System Control Space</i> .
0xE00FF004	DWT	0xFFF02003	See Table 11-1 on page 11-4.
0xE00FF008	FPB	0xFFF03003	See Table 9-7 on page 9-8.
0xE00FF00C	ITM	0xFFF01003 ^a	See Table 12-1 on page 12-4.
0xE00FF010	Reserved (TPIU)	0xFFF41002	Not present, TPIU not implemented inside Cortex-M7.
0xE00FF014	Reserved (ETM)	0xFFF42002	Not present, ETM is referenced by the Cortex-M7 Processor ROM table. See <i>Cortex-M7 Processor ROM table identification and entries</i> on page 9-3.
0xE00FF018	End marker	0x00000000	See <i>DAP accessible ROM table</i> in the <i>ARM®v7-M Architecture Reference Manual</i> .
0xE00FF0CC	SYSTEM ACCESS	0x00000001	

a. Reads as 0xFFF01002 if the ITM is not implemented.

The Cortex-M7 PPB ROM table entries point to the debug components of the processor. The offset for each entry is the offset of that component from the ROM table base address, 0xE00FF000.

See the *ARM®v7-M Architecture Reference Manual* and the *ARM® CoreSight™ Architecture Specification (v2.0)* for more information about the ROM table ID and component registers, and their addresses and access types.

9.1.3 System Control Space

The processor provides debug through registers in the SCS. See:

- *Debug register summary* on page 9-6.
- *System address map* on page 2-5.

SCS CoreSight identification

Table 9-5 shows the SCS CoreSight identification registers and values for debugger detection. Final debugger identification of the Cortex-M7 processor is through the CPUID register in the SCS. See *CPUID Base Register* on page 3-8.

Table 9-5 SCS identification values

Address	Register	Value	Description
0xE00EFD0	Peripheral ID4	0x00000004	Component and Peripheral ID register formats in the <i>ARM[®]v7-M Architecture Reference Manual</i>
0xE00EFD4	Peripheral ID5	0x00000000	
0xE00EFD8	Peripheral ID6	0x00000000	
0xE00EFD0	Peripheral ID7	0x00000000	
0xE00EFE0	Peripheral ID0	0x0000000C ^a	
0xE00EFE4	Peripheral ID1	0x000000B0	
0xE00EFE8	Peripheral ID2	0x0000000B	
0xE00EFEC	Peripheral ID3	0x00000000	
0xE00EFF0	Component ID0	0x0000000D	
0xE00EFF4	Component ID1	0x000000E0	
0xE00EFF8	Component ID2	0x00000005	
0xE00EFFF0	Component ID3	0x000000B1	

a. 0x0000000C SCS identification value for implementations without FPU.

See the *ARM[®]v7-M Architecture Reference Manual* and the *ARM[®] CoreSight[™] Architecture Specification (v2.0)* for more information about the ROM table ID and component registers, and their addresses and access types.

9.1.4 Debug register summary

Table 9-6 shows the debug registers. Each of these registers is 32 bits wide and is described in the *ARM[®]v7-M Architecture Reference Manual*.

Table 9-6 Debug registers

Address	Name	Type	Reset	Description
0xE00ED30	DFSR	RW	0x00000000 ^a	Debug Fault Status Register
0xE00EDF0	DHCSR	RW	0x00000000	Debug Halting Control and Status Register
0xE00EDF4	DCRSR	WO	-	Debug Core Register Selector Register
0xE00EDF8	DCRDR	RW	-	Debug Core Register Data Register
0xE00EDFC	DEMCR	RW	0x00000000	Debug Exception and Monitor Control Register

a. Power-on reset only.

9.2 About the AHBD interface

The 32-bit *AHB debug* (AHBD) interface implements the AMBA 3 AHB-Lite protocol.

It can be used with a CoreSight AHB-AP to provide debugger access to:

- All processor control and debug resources.
- A view of memory that is consistent with that observed by load/store instructions acting on the processor.

AHBD interface accesses are only in little-endian format. The processor ensures data is presented in the correct big- or little-endian format to the system. This is transparent to the debugger.

Note

- The instruction cache is not accessible to a debugger. Therefore debugger accesses to cacheable, executable regions of memory might not be coherent with the instructions visible to the instruction side of the processor.
 - The data cache must be enabled by setting the CCR.DC to 1 to read and write data to the cache. If CCR.DC is set to 0, all debug requests to memory regions outside the TCM and peripheral address space, access only the external memory on AXIM even if the debug request is marked as cacheable on the AHBD interface.
-

9.3 About the FPB

The FPB implements hardware breakpoints.

The FPB can be configured during implementation to provide either four or eight instruction comparators. You can configure each comparator individually to return a BKPT instruction to the processor on a match, to provide hardware breakpoint capability.

The FPB does not support Flash patching. The FP_REMAP register is not implemented and is RAZ/WI.

9.3.1 FPB functional description

The FPB contains both a global enable and individual enables for each of the comparators implemented. If the comparison for an entry matches, the address is remapped to a BKPT instruction if that feature is enabled.

If the FPB supports only four breakpoints then only comparators 0-3 are used, and comparators 4-7 are implemented as RAZ/WI.

9.3.2 FPB programmers model

Table 9-7 shows the FPB registers. Depending on the implementation of your processor, some of these registers might not be present. Any register that is configured as not present reads as zero.

Table 9-7 FPB register summary

Address	Name	Type	Reset	Description
0xE0002000	FP_CTRL	RW	0x10000040 ^a 0x10000080 ^b	FlashPatch Control Register
0xE0002004	FP_REMAP	RAZ/WI	-	Not implemented
0xE0002008	FP_COMP0	RW	0b00000000 ^c	FlashPatch Comparator Register0
0xE000200C	FP_COMP1	RW	0b00000000	FlashPatch Comparator Register1
0xE0002010	FP_COMP2	RW	0b00000000	FlashPatch Comparator Register2
0xE0002014	FP_COMP3	RW	0b00000000	FlashPatch Comparator Register3
0xE0002018	FP_COMP4	RW	0b00000000	FlashPatch Comparator Register4
0xE000201C	FP_COMP5	RW	0b00000000	FlashPatch Comparator Register5
0xE0002020	FP_COMP6	RW	0b00000000	FlashPatch Comparator Register6
0xE0002024	FP_COMP7	RW	0b00000000	FlashPatch Comparator Register7
0xE000FB0	FP_LAR	WO	-	FlashPatch Lock Access Register
0xE000FB4	FP_LSR	RO	Unknown	FlashPatch Lock Status Register

Table 9-7 FPB register summary (continued)

Address	Name	Type	Reset	Description
0xE0002FD0	PID4	RO	0x00000004	Peripheral identification registers
0xE0002FD4	PID5	RO	0x00000000	
0xE0002FD8	PID6	RO	0x00000000	
0xE0002FDC	PID7	RO	0x00000000	
0xE0002FE0	PID0	RO	0x0000000E	
0xE0002FE4	PID1	RO	0x000000B0	
0xE0002FE8	PID2	RO	0x0000000B	
0xE0002FEC	PID3	RO	0x00000000	
0xE0002FF0	CID0	RO	0x0000000D	Component identification registers
0xE0002FF4	CID1	RO	0x000000E0	
0xE0002FF8	CID2	RO	0x00000005	
0xE0002FFC	CID3	RO	0x000000B1	

- a. If four instruction comparators are implemented.
- b. If eight instruction comparators are implemented.
- c. For FP_COMP0 to FP_COMP7, bit 0 is reset to 0. Other bits in these registers are not reset.

All FPB registers are described in the *ARM®v7-M Architecture Reference Manual*.

Chapter 10

Cross Trigger Interface

This chapter describes the Cortex-M7 *Cross Trigger Interface* (CTI). It contains the following sections:

- [About the CTI on page 10-2.](#)
- [Cortex-M7 CTI functional description on page 10-3.](#)
- [CTI programmers model on page 10-5.](#)

10.1 About the CTI

If implemented, the CTI enables the debug logic and ETM to interact with each other and with other CoreSight components. This is called cross triggering. For example, you can configure the CTI to generate an interrupt when the ETM trigger event occurs.

10.2 Cortex-M7 CTI functional description

The Cortex-M7 CTI is connected to a number of trigger inputs and trigger outputs. [Figure 10-1](#) shows the debug system components and the available trigger inputs and trigger outputs.

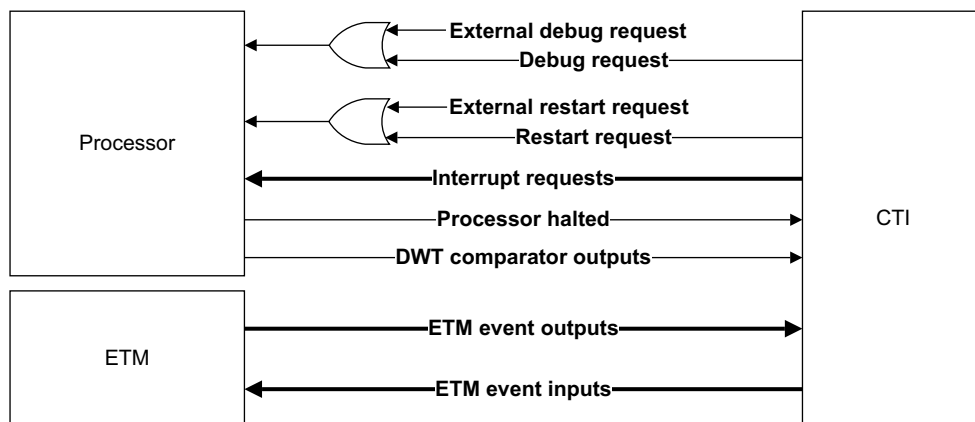

Figure 10-1 Debug system components

[Table 10-1](#) shows how the CTI trigger inputs are connected to the Cortex-M7 processor.

Table 10-1 Trigger signals to the CTI

Signal	Description	Connection	Acknowledge, handshake
CTITRIGIN[7]	ETM Event Output 3	ETM to CTI	Pulsed
CTITRIGIN[6]	ETM Event Output 2		
CTITRIGIN[5]	ETM Event Output 1		
CTITRIGIN[4]	ETM Event Output 0		
CTITRIGIN[3]	DWT Comparator Output 2	Processor to CTI	
CTITRIGIN[2]	DWT Comparator Output 1		
CTITRIGIN[1]	DWT Comparator Output 0		
CTITRIGIN[0]	Processor Halted		

[Table 10-2](#) shows how the CTI trigger outputs are connected to the processor and ETM.

Table 10-2 Trigger signals from the CTI

Signal	Description	Connection	Acknowledge, handshake
CTITRIGOUT[7]	Processor Restart	CTI to Processor	Processor Restarted
CTITRIGOUT[6]	ETM Event Input 3	CTI to ETM	Pulsed
CTITRIGOUT[5]	ETM Event Input 2		Pulsed
CTITRIGOUT[4]	ETM Event Input 1		Pulsed
CTITRIGOUT[3]	ETM Event Input 0		Pulsed

Table 10-2 Trigger signals from the CTI (continued)

Signal	Description	Connection	Acknowledge, handshake
CTITRIGOUT[2]	Interrupt request 1	CTI to system	Acknowledged by writing to the CTIINTACK register in ISR
CTITRIGOUT[1]	Interrupt request 0		
CTITRIGOUT[0]	Processor debug request	CTI to processor	Acknowledged by the debugger writing to the CTIINTACK register

Note

- After the processor is halted using CTI Trigger Output 0, the Processor Debug Request signal remains asserted. The debugger must write to CTIINTACK to clear the halting request before restarting the processor.
 - After asserting an interrupt using the CTI Trigger Output 1 or 2, the *Interrupt Service Routine* (ISR) must clear the interrupt request by writing to the CTI Interrupt Acknowledge, CTIINTACK.
-

10.3 CTI programmers model

Table 10-3 shows the CTI programmable registers. See the *ARM® CoreSight™ SoC-400 Technical Reference Manual* for register descriptions.

Table 10-3 CTI register summary

Address offset	Register name	Type	Reset value	Description
0x000	CTICONTROL	RW	0x00000000	CTI Control Register
0x010	CTIINTACK	WO	0x00000000	CTI Interrupt Acknowledge Register
0x014	CTIAPPSET	RW	0x00000000	CTI Application Trigger Set Register
0x018	CTIAPPCLEAR	RW	0x00000000	CTI Application Trigger Clear Register
0x01C	CTIAPPULSE	WO	0x00000000	CTI Application Pulse Register
0x020-0x03C	CTIINEN[7:0]	RW	0x00000000	CTI Trigger to Channel Enable Registers
0x0A0-0x0BC	CTIOUTEN[7:0]	RW	0x00000000	CTI Channel to Trigger Enable Registers
0x130	CTITRIGINSTATUS	RO	0x00000000	CTI Trigger In Status Register
0x134	CTITRIGOUTSTATUS	RO	0x00000000	CTI Trigger Out Status Register
0x138	CTICHINSTATUS	RO	0x00000000	CTI Channel In Status Register
0x140	CTIGATE	RW	0x00000000	Enable CTI Channel Gate register
0x144	ASICCTL	RW	0x00000000	External Multiplexer Control register
0xEDC	ITCHINACK	WO	0x00000000	Integration Test Channel Input Acknowledge register
0xEE0	ITTRIGINACK	WO	0x00000000	Integration Test Trigger Input Acknowledge register
0xEE4	ITCHOUT	WO	0x00000000	Integration Test Channel Output register
0xEE8	ITTRIGOUT	WO	0x00000000	Integration Test Trigger Output register
0xEEC	ITCHOUTACK	WO	0x00000000	Integration Test Channel Output Acknowledge register
0xEF0	ITTRIGOUTACK	RO	0x00000000	Integration Test Trigger Output Acknowledge register
0xEF4	ITCHIN	RO	0x00000000	Integration Test Channel Input register
0xEF8	ITTRIGIN	RO	0x00000000	Integration Test Trigger Input register
0xF00	ITCTRL	RW	0x00000000	Integration Mode Control register
0xFA0	CLAIMSET	RW	0x0000000F	Claim Tag Set register
0xFA4	CLAIMCLR	RW	0x00000000	Claim Tag Clear register
0xFB0	LAR	WO	0x00000000	Lock Access Register
0xFB4	LSR	RO	0x00000003	Lock Status Register
0xFB8	AUTHSTATUS	RO	0x00000005	Authentication Status register
0xFC8	DEVID	RO	0x00040800	Device Configuration register

Table 10-3 CTI register summary (continued)

Address offset	Register name	Type	Reset value	Description
0xFCC	DEVTYPE	RO	0x00000014	Device Type Identifier register
0xFD0	PIDR4	RO	0x00000004	Peripheral ID4 Register
0xFD4	-	-	-	Reserved
0xFD8	-	-	-	Reserved
0xFDC	-	-	-	Reserved
0xFE0	PIDR0	RO	0x00000006	Peripheral ID0 Register
0xFE4	PIDR1	RO	0x000000B9	Peripheral ID1 Register
0xFE8	PIDR2	RO	0x0000004B	Peripheral ID2 Register
0xFEC	PIDR3	RO	0x00000000	Peripheral ID3 Register
0xFF0	CIDR0	RO	0x00000000	Component ID0 Register
0xFF4	CIDR1	RO	0x00000090	Component ID1 Register
0xFF8	CIDR2	RO	0x00000005	Component ID2 Register
0xFFC	CIDR3	RO	0x000000B1	Component ID3 Register

Chapter 11

Data Watchpoint and Trace Unit

This chapter describes the *Data Watchpoint and Trace* (DWT) unit. It contains the following sections:

- *About the DWT* on page 11-2.
- *DWT functional description* on page 11-3.
- *DWT programmers model* on page 11-4.

11.1 About the DWT

The DWT is a debug unit that provides watchpoints and system profiling for the processor. Data tracing is also available if the processor has been implemented with DWT and ITM trace. See [Chapter 12 Instrumentation Trace Macrocell Unit](#) for details about the ITM.

11.2 DWT functional description

A full DWT contains four comparators that you can configure as:

- A hardware watchpoint.
- An ETM trigger.
- A PC sampler event trigger.
- A data address sampler event trigger.

The first comparator, DWT_COMP0, can also compare against the clock cycle counter, CYCCNT. You can also use the second comparator, DWT_COMP1, as a data comparator.

A reduced DWT contains two comparators that you can use as a watchpoint or as a trigger. The comparators support data matching.

The DWT if present contains counters for:

- Clock cycles, CYCCNT.
- Folded instructions.
- *Load Store Unit* (LSU) operations.
- Sleep cycles.
- CPI, that is all instruction cycles except for the first cycle.
- Interrupt overhead.

Note

An event is generated each time a counter overflows.

You can configure the DWT to generate PC samples at defined intervals, and to generate interrupt event information.

The DWT provides periodic requests for protocol synchronization to the ITM.

11.3 DWT programmers model

Table 11-1 shows the DWT registers. Depending on the implementation of your processor, some of these registers might not be present. Any register that is configured as not present reads as zero.

Table 11-1 DWT register summary

Address	Name	Type	Reset	Description
0xE0001000	DWT_CTRL	RW	See ^a	Control Register
0xE0001004	DWT_CYCCNT	RW	0x00000000	Cycle Count Register
0xE0001008	DWT_CPICNT	RW	-	CPI Count Register
0xE000100C	DWT_EXCCNT	RW	-	Exception Overhead Count Register
0xE0001010	DWT_SLEEPCNT	RW	-	Sleep Count Register
0xE0001014	DWT_LSUCNT	RW	-	LSU Count Register
0xE0001018	DWT_FOLDCNT	RW	-	Folded-instruction Count Register
0xE000101C	DWT_PCSR	RO	-	Program Counter Sample Register
0xE0001020	DWT_COMP0	RW	-	Comparator Register 0
0xE0001024	DWT_MASK0	RW	-	Mask Register 0
0xE0001028	DWT_FUNCTION0	RW	0x00000000	Function Register 0
0xE0001030	DWT_COMP1	RW	-	Comparator Register 1
0xE0001034	DWT_MASK1	RW	-	Mask Register 1
0xE0001038	DWT_FUNCTION1	RW	0x00000000 ^b	Function Register 1
0xE0001040	DWT_COMP2	RW	-	Comparator Register 2
0xE0001044	DWT_MASK2	RW	-	Mask Register 2
0xE0001048	DWT_FUNCTION2	RW	0x00000000	Function Register 2
0xE0001050	DWT_COMP3	RW	-	Comparator Register 3
0xE0001054	DWT_MASK3	RW	-	Mask Register 3
0xE0001058	DWT_FUNCTION3	RW	0x00000000	Function Register 3
0xE000FB0	DWT_LAR	WO	-	Lock Access Register
0xE000FB4	DWT_LSR	RO	Unknown	Lock Status Register

Table 11-1 DWT register summary (continued)

Address	Name	Type	Reset	Description
0xE0001FD0	PID4	RO	0x00000004	Peripheral identification registers
0xE0001FD4	PID5	RO	0x00000000	
0xE0001FD8	PID6	RO	0x00000000	
0xE0001FDC	PID7	RO	0x00000000	
0xE0001FE0	PID0	RO	0x00000002	
0xE0001FE4	PID1	RO	0x000000B0	
0xE0001FE8	PID2	RO	0x0000000B	
0xE0001FEC	PID3	RO	0x00000000	
0xE0001FF0	CID0	RO	0x0000000D	Component identification registers
0xE0001FF4	CID1	RO	0x000000E0	
0xE0001FF8	CID2	RO	0x00000005	
0xE0001FFC	CID3	RO	0x000000B1	

- a. Possible reset values are:
 - 0x40000000 for full DWT, with trace.
 - 0x48000000 for full DWT, without trace.
 - 0x20000000 for reduced DWT, with trace.
 - 0x28000000 for reduced DWT, without trace.
- b. If the processor is configured for minimal debug, the DWT_FUNCTION1[9] is always RAZ. If the processor is configured for full debug, the DWT_FUNCTION1[9] is always RA0. All other bits in the DWT_FUNCTION1 register are reset to zero.

DWT registers are described in the *ARM®v7-M Architecture Reference Manual*.

Note

- Cycle matching functionality is only available in comparator 0.
- Data matching functionality is only available in comparator 1.
- Data value is only sampled for accesses that do not produce an MPU or bus fault. The PC is sampled irrespective of any faults. The PC is only sampled for the first address of a burst.
- The FUNCTION field in the DWT_FUNCTION1 register is overridden for comparators given by DATAVADDR0 and DATAVADDR1 if DATAVMATCH is also set in DWT_FUNCTION1. The comparators given by DATAVADDR0 and DATAVADDR1 can then only perform address comparator matches for comparator 1 data matches.
- ARM does not recommend PC match for watchpoints because watchpoints are asynchronous to the event that causes them. It mainly guards and triggers the ETM.

Chapter 12

Instrumentation Trace Macrocell Unit

This chapter describes the *Instrumentation Trace Macrocell* (ITM) unit. It contains the following sections:

- [About the ITM on page 12-2.](#)
- [ITM functional description on page 12-3.](#)
- [ITM programmers model on page 12-4.](#)

12.1 About the ITM

The ITM is a an optional application-driven trace source that supports `printf()` style debugging to trace operating system and application events, and generates diagnostic system information.

12.2 ITM functional description

The ITM generates trace information as packets. There are four sources that can generate packets. If multiple sources generate packets at the same time, the ITM arbitrates the order that packets are output. The four sources in decreasing order of priority are:

Software trace Software can write directly to ITM stimulus registers to generate packets.

Hardware trace The DWT generates these packets, and the ITM outputs them.

Time stamping Timestamps are generated relative to packets. The ITM contains a 21-bit counter to generate the timestamp. The processor clock output clocks the counter.

Global system timestamping

Timestamps can optionally be generated using a system-wide 64-bit count value. The same count value is used for inserting timestamps in the ETM trace stream, permitting coarse-grain correlation.

12.3 ITM programmers model

Table 12-1 shows the ITM registers whose implementation is specific to this processor. Other registers are described in the *ARM[®]v7-M Architecture Reference Manual*.

Depending on the implementation of your processor, the ITM registers might not be present. Any register that is configured as not present reads as zero.

———— **Note** —————

- You must enable TRCENA of the Debug Exception and Monitor Control Register before you program or use the ITM.
- If the ITM stream requires synchronization packets, you must configure the synchronization packet rate in the DWT.

Table 12-1 ITM register summary

Address	Name	Type	Reset	Description
0xE0000000- 0xE000007C	ITM_STIM0- ITM_STIM31	RW	-	Stimulus Port Registers 0-31
0xE0000E00	ITM_TER	RW	0x00000000	Trace Enable Register
0xE0000E40	ITM_TPR	RW	0x00000000	ITM Trace Privilege Register on page 12-5
0xE0000E80	ITM_TCR	RW	0x00000000	Trace Control Register
0xE0000EF0	ITM_ITATRDY	RO	Unknown	Integration Mode: Read ATB Ready
0xE0000EF8	ITM_ITATVAL	WO	-	Integration Mode: Write ATB Valid
0xE0000F00	ITM_TCTRL	RW	0x00000000	Integration Mode Control Register
0xE0000FB0	ITM_LAR	WO	-	Lock Access Register
0xE0000FB4	ITM_LSR	RO	Unknown	Lock Status Register
0xE0000FD0	PID4	RO	0x00000004	Peripheral identification registers
0xE0000FD4	PID5	RO	0x00000000	
0xE0000FD8	PID6	RO	0x00000000	
0xE0000FDC	PID7	RO	0x00000000	
0xE0000FE0	PID0	RO	0x00000001	
0xE0000FE4	PID1	RO	0x000000B0	
0xE0000FE8	PID2	RO	0x0000000B	
0xE0000FEC	PID3	RO	0x00000000	
0xE0000FF0	CID0	RO	0x0000000D	Component identification registers
0xE0000FF4	CID1	RO	0x000000E0	
0xE0000FF8	CID2	RO	0x00000005	
0xE0000FFC	CID3	RO	0x000000B1	

Note

ITM registers are fully accessible in privileged mode. In user mode, all registers can be read, but only the Stimulus Registers and Trace Enable Registers can be written, and only when the corresponding Trace Privilege Register bit is set. Invalid user mode writes to the ITM registers are discarded.

12.3.1 ITM Trace Privilege Register

The ITM_TPR characteristics are:

- Purpose** Enables an operating system to control the stimulus ports that are accessible by user code.
- Usage constraints** You can only write to this register in privileged mode.
- Configurations** This register is available if the ITM is configured in your implementation.
- Attributes** See [Table 12-1 on page 12-4](#).

[Figure 12-1](#) shows the ITM_TPR bit assignments.

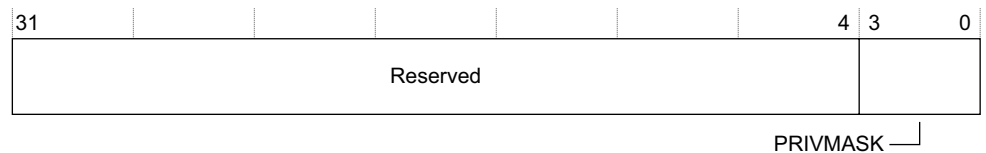

Figure 12-1 ITM_TPR bit assignments

[Table 12-2](#) shows the ITM_TPR bit assignments.

Table 12-2 ITM_TPR bit assignments

Bits	Name	Function
[31:4]	-	Reserved.
[3:0]	PRIVMASK	Bit mask to enable tracing on ITM stimulus ports: <ul style="list-style-type: none"> Bit[0] Stimulus ports [7:0]. Bit[1] Stimulus ports [15:8]. Bit[2] Stimulus ports [23:16]. Bit[3] Stimulus ports [31:24].

Chapter 13

Fault detection and handling

This chapter describes the fault detection and handling features of the Cortex-M7 processor. It contains the following sections:

- *About fault detection and handling on page 13-2.*
- *Cache RAM protection on page 13-3.*
- *Logic protection on page 13-6.*

13.1 About fault detection and handling

The Cortex-M7 processor fault detection and handling features:

- Report any detected error to the system.
- Correct any detected and correctable error.

When the system-on-chip reports a failure, the logging and status must provide all the required information to identify the source of the failure. The intention is to detect and correct the errors as much as possible, and identify them to the system.

For *Error Correcting Code* (ECC) on RAM, all errors explicitly seen must be reported, so that the error propagation is minimized.

13.1.1 RAM and logic protection

The processor protects memories and logic in two different ways.

- The RAMs are protected with ECC.
- The logic of the individual processors is protected by duplication with diagnostic compare. This is known as redundant logic in a lock-step implementation.

These are independent, and can be used separately.

The processor uses *Single Error Correction* and *Double Error Detection* (SEC-DED) ECCs to detect and correct errors in the RAMs. A finite number of hard, that is, permanent errors can be detected and corrected with continued normal operation using dedicated error registers.

13.1.2 Analysis of errors

A monitor external to the processor is responsible for analyzing the notified error and marking the corrupted entries as reusable if it has been proven to be a soft error. This analysis can be performed by reading and writing the RAM directly through the processor MBIST interface.

13.2 Cache RAM protection

The following sections describe RAM protection:

- [Protection method](#).
- [RAM protection summary on page 13-4](#).
- [ECC codes on page 13-4](#).
- [RAM configuration on page 13-5](#).
- [Performance impact on page 13-5](#).

13.2.1 Protection method

The following sections describe how RAM errors are managed:

- [Detecting errors](#).
- [Recovering from errors](#).
- [Handling permanent errors](#).
- [Error bank register behavior on page 13-4](#).

Detecting errors

The Cortex-M7 processor uses ECC to detect errors in the cache RAMs.

Recovering from errors

The Cortex-M7 processor can recover from a RAM error detected in the cache by using clean and invalidate and retry. When an error is detected, as shown in [Table 13-1 on page 13-4](#), the corresponding index/way is cleaned and invalidated. When the clean and invalidate operation completed, the requester retries its access. The ECC can also be used to correct single-bit errors in the RAM.

Instruction cache

In the instruction cache, lines are always clean so that invalidating the line is sufficient. The retried access then fetches the correct value from external memory.

Data cache

In the data cache, the cache line can be dirty. The correction of the RAM contents is done as part of the clean and invalidate operation for caches. This takes place in the write buffer and the corrected data is written back to external memory. The retried access then reads the correct value from external memory. If the data cannot be corrected then the error is non-recoverable.

Handling permanent errors

Permanent errors are handled as follows:

General behavior

If hard, or permanent, errors occur on the RAMs, the clean, invalidate and retry scheme might cause a deadlock, and the access is continuously replayed. To prevent this, error bank registers are provided to mask the faulty locations as unusable and invalid. There are two banks for each side of the memory system. When an error is detected, the location is pushed in the bank, masking the corresponding valid bit of the location when reading and when allocating a new

line. The line is therefore no longer used unless the entry is reset. Because of implementation details, there is a short period of time when the line is still seen by the system, but is removed from the allocation pool.

The depth of the error bank determines how many errors can be supported by the system. When this limit is reached, the system might livelock. The processor provides information to the system indicating the number of corrupted locations to monitor the error bank status before it becomes full. This is a condition that can cause a potential deadlock. This information is reported on several pins signaling the use of the error bank, that is, showing if the error bank is empty or at least one error has been encountered.

Error bank register behavior

Both the instruction and data side use the same algorithm to select the bank to update:

- If there is a non-valid, unlocked bank then it is always allocated in preference to a valid bank.
- If both banks are valid, or both banks are non-valid, and both are not locked then a round-robin counter updated on each allocation selects the bank to fill.
- If there is one locked bank then the other bank is always allocated, whether or not it is already valid.
- If both banks are locked then no allocation takes place.

13.2.2 RAM protection summary

Table 13-1 shows how the different types of RAM are protected.

Table 13-1 RAM protection summary

RAM type	Protection	Recoverable error	Non-recoverable error	Hard error support
Data tag RAM	SEC-DED ECC	Error seen as single bit errors	Error seen as a multiple bit error	Up to two hard errors
Data cache data RAM	SEC-DED ECC	Error seen as single bit errors	Error seen as a multiple bit error on dirty lines	
Instruction tag RAM	SEC-DED ECC	Any error, single or double, on the tag or valid bit stored in the RAM	None ^a	
Instruction cache data RAM	SEC-DED ECC	Any error on the data stored in the RAM	None ^a	

a. The instruction cache is never dirty so cache RAM errors are always recoverable by invalidating the cache and retrying the instruction.

13.2.3 ECC codes

When implemented, the instruction and data caches have:

- Separate 32-bit ECC codes with seven check bits, one for:
 - Instruction cache tag RAM, that is RAM index, tag value, outer attributes and valid bit.
 - Data cache data RAM.

- Data cache data tag RAM, that is the RAM index, tag value, outer attributes, valid bit and dirty bit.
- A 64-bit ECC code with eight check bits for the instruction cache data RAM.

13.2.4 RAM configuration

Table 13-2 shows the RAM configuration with or without ECC when the processor is implemented with 4KB instruction and data cache.

Table 13-2 RAM configuration with or without ECC

RAM	Storage for a RAM set without ECC	Storage for a RAM set with ECC
Data tag RAM	4x26 bits	4x(26+7) bits
Data data RAM	8x32 bits	8x(32+7) bits
Instruction tag RAM	4x22 bits	4x(22+7) bits
Instruction data RAM	4x64 bits	4x(64+8) bits

13.2.5 Performance impact

In an error-free system, the major performance impact is the cost of the read-modify-write scheme for non-full stores in the data side. If a store buffer slot does not contain at least a full 32-bit word, it must read the word to be able to compute the check bits. This can occur because software only writes to an area of memory with byte or halfword store instructions. The data can then be written in the RAM. This additional read can have a negative impact on performance because it prevents the slot from being used for another write.

The buffering and outstanding capabilities of the memory system mask part of the additional read, and it is negligible for most codes. However, ARM recommends that you use as few cacheable STRB and STRH instructions as possible to reduce the performance impact.

———— **Note** —————

There might be a frequency impact because XOR trees are added on the data returned from the RAMs.

13.3 Logic protection

The processor logic can be protected by a duplicate, redundant, processor, that is the exact copy of the first processor. Both processors share the same RAMs protected with ECC and the same input pins. The second processor is delayed by two clock cycles so that this redundant system can detect glitches in the inputs.

The outputs of the two processors are compared on each cycle to detect any error. The outputs of the first processor are delayed so they can be synchronized with the second processor. This mechanism relies on the fact that any error occurring in the processor is eventually visible on the outputs of the processor, or is inherently a safe failure.

On detection of an error in one processor, both processors are reset before executing a code sequence, to put them in the same initial state. They can then restart execution from a previously taken snapshot.

The processor provides a template of the logic required for the comparison of the two processors.

Appendix A

Revisions

This appendix describes the technical changes between released issues of this book.

Table A-1 Issue A

Change	Location	Affects
First release	-	-

Table A-2 Differences between issue A and issue B

Change	Location	Affects
ARM [®] v7-M Architecture Reference Manual, issue E.b, defines Flash Patch Breakpoint version 2	ARM architecture on page 1-13	r0p2 onwards
Prefix CM7_ added to register names ITCMCR, DTCMCR, CACR, AHBSCR, ABFSR and AHBPCR	-	r0p2
Cortex-M7 processor features clarified	Features on page 1-2	All revisions
Implementation options table updated	Table 1-1 on page 1-4	All revisions
Data Process Unit changed to Data Processing Unit	Data Processing Unit on page 1-7	All revisions
Single MAC pipeline description clarified	Data Processing Unit on page 1-7	All revisions
Prefetch Unit features clarified	Prefetch Unit on page 1-7	All revisions
ETM block description clarified	Cross Trigger Interface Unit on page 1-9	All revisions
TCM interface description clarified	TCM interface on page 1-11	All revisions

Table A-2 Differences between issue A and issue B (continued)

Change	Location	Affects
MBIST interface description clarified	<i>MBIST interface on page 1-12</i>	All revisions
Binary compatibility with other Cortex processors section updated	<i>Binary compatibility with other Cortex processors on page 2-4</i>	All revisions
Exclusive monitor description clarified	<i>Exclusive monitor on page 2-7</i>	All revisions
Private peripheral bus section updated	<i>Private peripheral bus on page 2-6</i>	All revisions
Exception handling section updated	<i>Exception handling on page 2-9</i>	All revisions
System control registers table updated	Table 3-1 on page 3-3	r0p2
Added ACTLR field descriptions for new system dependent optimization modes	<i>Auxiliary Control Register on page 3-6</i>	r0p2
CPUID.REVISION function updated	Table 3-4 on page 3-8	r0p2
CLIDR bit assignments table updated	Table 3-5 on page 3-10	r0p2
CCSIDR bit assignments figure clarified	<i>CCSIDR bit assignments on page 3-10</i>	All revisions
CCSIDR.Associativity function updated	Table 3-6 on page 3-11	r0p2
AHBP Control Register clarified	<i>AHBP Control Register on page 3-14</i>	All revisions
CACR[1] name and function updated	Table 3-11 on page 3-16	r0p2
CACR[0] function updated	Table 3-11 on page 3-16	All revisions
Changed RAZ to RAO in Note	<i>About Initialization on page 4-2</i>	All revisions
Note clarified	<i>Preloading TCM on page 4-5</i>	All revisions
Changed AHBP peripheral interface to AHBP interface	<i>About the memory system on page 5-2</i>	All revisions
Changed AHBP peripheral port to AHBP port	<i>Fault handling on page 5-3</i>	All revisions
Write ID capability description clarified	Table 5-3 on page 5-6	All revisions
ARADDR value for address 0x10 updated	Table 5-20 on page 5-19	All revisions
TCM attributes and permissions section updated	<i>TCM attributes and permissions on page 5-33</i>	r0p1 and r0p2
Store buffer behavior clarified	<i>Store buffer on page 5-38</i>	All revisions
Low power modes section updated	<i>Low power modes on page 7-3</i>	All revisions
Processor ROM table identification values addresses updated	Table 9-1 on page 9-3	All revisions
Processor ROM table components table updated	Table 9-2 on page 9-4	All revisions
FPB register summary table updated	Table 9-7 on page 9-8	All revisions
DWT register summary table updated	Table 11-1 on page 11-4	All revisions
Error bank register behavior section added	<i>Protection method on page 13-3</i>	All revisions

Table A-3 Differences between issue B and issue C

Change	Location	Affects
Bullet list updated	<i>About the Cortex-M7 processor on page 1-2</i>	r1p0
Features updated	<i>Features on page 1-2</i>	r1p0
Memory system section updated	<i>Memory System on page 1-9</i>	r1p0
Store Buffer section added	<i>Store Buffer on page 1-9</i>	All revisions
CPUID reset value updated	<i>Table 3-1 on page 3-3</i>	r1p0
ACTLR bit functions updated	<i>Table 3-3 on page 3-7</i>	All revisions
CPUID.VARIANT and CPUID.REVISION functions updated	<i>Table 3-4 on page 3-8</i>	r1p0
CSSELR bit assignments table updated	<i>Table 3-8 on page 3-12</i>	All revisions
AHB slave interface section updated	<i>AHB slave interface on page 5-30</i>	r1p0
Memory map section added	<i>Memory map on page 5-30</i>	r1p0
Restrictions on AHBS transactions section updated	<i>Restrictions on AHBS transactions on page 5-30</i>	r1p0
AHBS interface arbitration section updated	<i>AHBS interface arbitration on page 5-31</i>	r1p0
TCM interfaces section updated	<i>TCM interfaces on page 5-33</i>	r1p0
Note added	<i>TCM attributes and permissions on page 5-33</i>	r1p0
TCM configuration section updated	<i>TCM configuration on page 5-34</i>	r1p0
TCM arbitration section updated	<i>TCM arbitration on page 5-34</i>	r1p0
TCM interface protocol section updated	<i>TCM interface protocol on page 5-34</i>	r1p0
TCM read modify write section added	<i>TCM read modify write on page 5-35</i>	r1p0
Bootting from TCM section added	<i>Bootting from TCM on page 5-35</i>	r1p0
Integration with Flash memory section added	<i>Integration with Flash memory on page 5-35</i>	r1p0
System access to TCM section added	<i>System access to TCM on page 5-35</i>	r1p0

Table A-4 Differences between issue C and issue D

Change	Location	Affects
Updated note about the ARM architecture interworking model	<i>Exceptions on page 2-9</i>	All revisions
CPUID.VARIANT and CPUID.REVISION functions updated	<i>Table 3-1 on page 3-3</i>	r1p1
Added a note to the CPUID register description	<i>CPUID Base Register on page 3-8</i>	All revisions
Invalidate the entire data cache description updated	<i>Initializing and enabling the L1 cache on page 4-3</i>	All revisions